



PROFESSIONAL AV SOLUTIONS
2018 EMEA Catalog

A MESSAGE FROM CHIEF

We're excited about the new additions to the Chief line, developed with feedback from our customers. Thank you for sharing your time and input at tradeshows, online or with your sales representative. It all helps us focus on the best new opportunities to improve your experiences with technology.

For example, the PRSU Portable Flat Panel Stand design was informed by AV professionals who work in the rental and staging space every day. The PRSU was made to be intuitive to set up so anyone can figure it out quickly - no tools necessary. It withstands long term wear and tear, and it folds up for easy space savings.

Chief has added many solutions for the digital signage market. The Freestyle Rotation Adapter opens new, creative video wall possibilities with the ability to rotate the display to any angle on Fusion or ConnexSys series mounts. Floor-to-Ceiling plates provide an aesthetic solution that adds stability to locations where the ceiling or wall aren't available or able to support an installation. Chief has several new solutions to accommodate the unique 600 x 200 VESA® patterns found on stretched displays, providing easy installation and rigid support to keep the display stable for optimal experience. Available in cart, stand, wall and ceiling options.

For storage of equipment near the display, we created the CSPH Under-Table Component Storage Panel and the CSPR Component Storage Panel that fits behind Fusion mounts. Both provide a large, easy-to-organize space for AV equipment.

We also have two new Kontour multi-monitor options to install three or four monitors on a single column - a great solution for control room and trading floor applications.

Beyond products, we've had another big change in 2017. Chief and the other Milestone AV Technologies brands were acquired by Legrand, the global specialist in electrical and digital building infrastructures. This acquisition grows the number of industry-leading brands operating together under one umbrella. We're excited about all the possibilities this opens up, and are looking forward to finding new ways of working together to provide innovative AV solutions and exceed your expectations.

I hope you find this news as exciting as we do. Keep telling us how we can better help you and we'll keep improving together!



Jan Mergen

Vice President - Sales & Marketing
EMEA Commercial



FREESTYLE VIDEO WALL



KONTOUR CONTROL ROOM

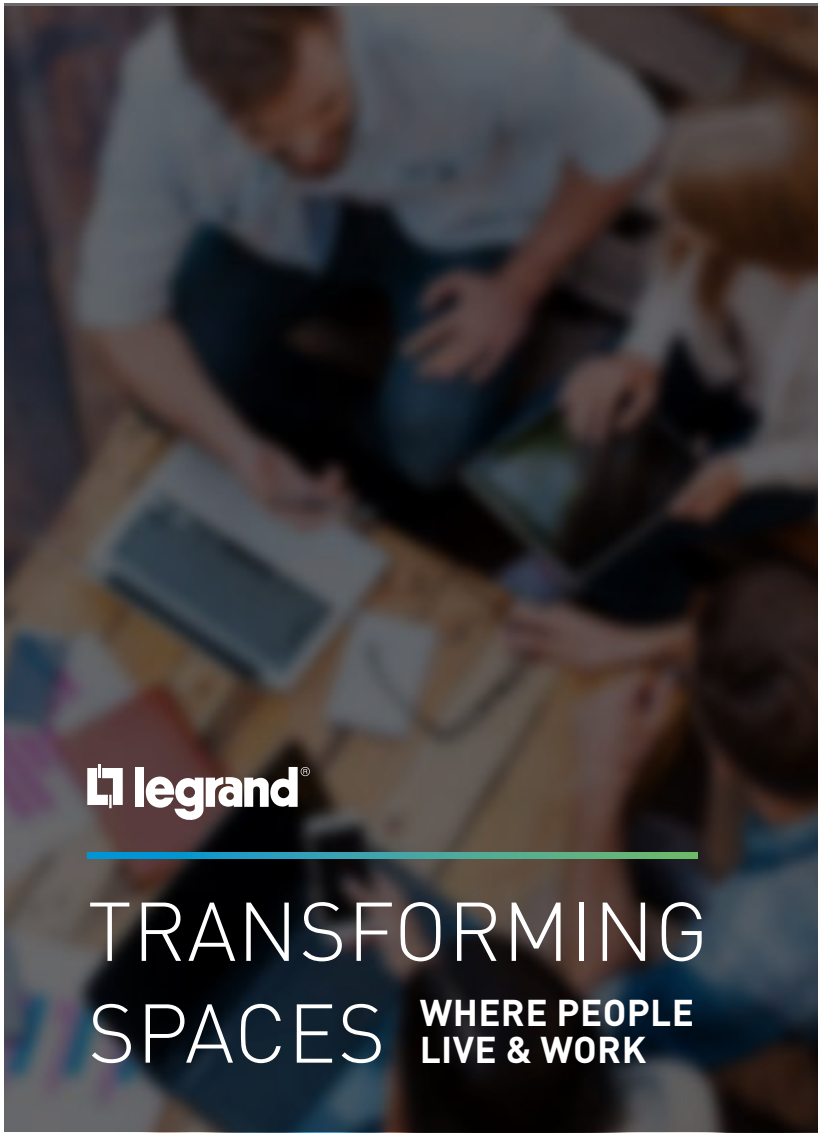

Legrand is the global specialist in electrical and digital building infrastructures. Its comprehensive offering of solutions for commercial, industrial and residential markets makes it a benchmark for customers worldwide. In the AV space, Legrand offers an extended portfolio of branded audiovisual products including flat panel mounting solutions, projector mounts, projection screens, equipment racks, PTZ cameras and furniture for AV markets. Its innovative products are sold under the Chief, Da-Lite, Middle Atlantic, Projecta, Vaddio and Sanus brand names. All brands work together to provide a breadth of product, strength of longevity, and advantage of superior customer service and support.

CHIEF

Chief focuses on commercial AV flat panel and projector mounts. Home Theater, Workstation and Custom Display Solutions are also part of the Chief product offering. Known in the industry for high quality mounts with both Custom and Universal options, as well as an extensive accessories line, Chief is focused on professional installers worldwide.

DA-LITE

For over 100 years, Da-Lite has been designing, manufacturing and marketing the most comprehensive line of projection screens in the world. Today, we offer our widest selection ever of proprietary projection screen fabrics and materials in our history.

PROJECTA

Projecta is Europe's leading manufacturer of high quality projection screens. We design, develop and build an extensive range of projection screens in the largest projection screen manufacturing facility in Europe, located in Weert, the Netherlands. Founded in 1952, we have 60 years of experience, and over time we have grown to become your trusted source for projection screen solutions.

vaddio

Vaddio manufactures professional quality PTZ cameras, Pro AV solutions and a full suite of Unified Communication and Collaboration systems. Combining enterprise class performance and industry leading support, Vaddio products enhance any AV experience by elevating the science of communication.



DESIGNED FOR EVERY STAGE



Using feedback from people who work with temporary AV set ups every day, the Portable Flat Panel Stand, PRSU, is designed for every stage of use. From storage to transport to set up to teardown, our development team worked to improve the user experience, making everything easier and more efficient. No tools are needed, and most people can set it up in under two minutes, even the first time.

The PRSU quickly breaks down to take up less storage space. Add the custom PAC900 case for stackable, wheeled storage that keeps the components organized, and in the order needed for setup and teardown. Additional accessories include the PAC910 shelf and PAC400 portrait-to-landscape rotation adapter.

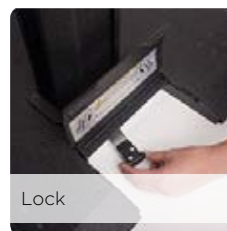
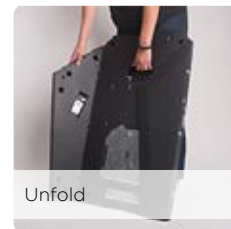
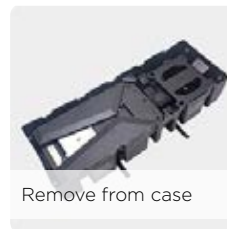

AWARDS

PORTABLE FLAT PANEL STAND, PRSU

- Product of the Year - SCN - 2017

XL IN-WALL STORAGE BOX, PAC527

- Best AV Mount Product - rAve Best of InfoComm - 2017
- Best of Show - AV Technology - 2017
- InfoComm Installation Product Award - SCN - 2017

OUTDOOR WALL MOUNT, ODMLA25

- BEST Award - Commercial Integrator - 2017

DYNAMIC HEIGHT ADJUST MOUNTS

- Top New Technology - Commercial Integrator - 2017

HEAVY DUTY FLAT PANEL WALL MOUNT, PSMH2079

- Product & Innovation that Defined 2016 - Commercial Integrator - 2016

FAVORITE MOUNT MANUFACTURER

- rAve Readers' Choice Award - 2017





ONLINE TOOLS

In our continuing effort to be the easiest manufacturing partner to work with, Chief has a host of online tools and resources to make your next project as easy as possible.

FUSION MULTI-DISPLAY CONFIGURATOR

Chief's Fusion Multi-Display Configurator allows you to build and order the parts necessary to meet your exact application requirements. Enter the number of displays, orientation and configuration details and we'll build a customized parts list of Fusion components to safely meet the exact specification

[*milestone.com/fusionconfigurator*](https://milestone.com/fusionconfigurator)

VIDEOS & ANIMATIONS

Learn about our product features and how easy they are to install. View our videos or download them to look at later. They can also be embedded into your presentations or easily forwarded to coworkers.

[*milestone.com/videos*](https://milestone.com/videos)

CHIEF IMAGE LIBRARY

Get all the product shots, application photos and videos you need for your website and marketing collateral on Chief's new Image Library. Register online to gain access!

[*milestone.tandemvault.com*](https://milestone.tandemvault.com)

AV CONSULTANT'S CORNER

Chief's AV Consultant's Corner is our resource for Architects, Consultants and Designers. Chief also provides architects and designers with relevant downloadable documentation for many products - BIM Objects, CAD drawings, tech drawings and manuals. The documents can be found on the downloads tab of all our product pages.

[*milestone.com/consultantscorner*](https://milestone.com/consultantscorner)

LITERATURE DOWNLOADS

Find product lines, brochures, new product flyers, whitepapers and application-focused solutions on the Chief literature page, where you can download, print or request copies.

[*milestone.com/literature*](https://milestone.com/literature)

THROW DISTANCE CALCULATOR

Choose from an extensive lists of projectors and adjust room lighting, screen gain, application and diagonal to find the optimum distance for top performance.

[*milestone.com/projectorcalc*](https://milestone.com/projectorcalc)

AUTOMATED PRODUCT SERIAL COMMAND CALCULATOR

Find serial commands for Chief's automated solutions by selecting a product and address.

[*milestone.com/automatedcontrols*](https://milestone.com/automatedcontrols)

AV UNIVERSITY

AV University is home to Chief, Da-Lite, Projecta and Vaddio training courses, including product certification. All courses are free and many offer CTS Renewal Unit credits. The program allows you to pick and choose your courses and you can learn on your own time, at your own pace.

[*milestone.com/training*](https://milestone.com/training)

TABLE OF CONTENTS

QUICK REFERENCE CHARTS

- | | |
|---------------------------------------|--|
| 6 - 7 Projector Mounts | 12 - 13 Freestanding Display Mounts |
| 7 - 9 Wall Display Mounts | 14 - 16 Monitor Mounts |
| 10 - 11 Ceiling Display Mounts | |

PROJECTOR MOUNTS

- | | |
|---|---|
| 18 - 20 Elite® Series Projector Mounts | 26 Suspended Ceiling Storage Solutions |
| 21 RPEU® Series Ceiling Mounts | 27 - 28 Automated Projector Mounts & Accessories |
| 22 Projector Mount System | 29 - 30 WM Series Short Throw Mounts |
| 23 Application Specific Ceiling Projector Mounts | 31 WP2 Series Short Throw Mounts |
| 24 - 25 Ceiling Projector Mount Accessories | |

WALL DISPLAY MOUNTS

- | | |
|--|---|
| 32 - 37 Fusion® Fixed Mounts, ViewShare & Accessories | 46 Other Tilt Wall Mounts |
| 38 Thinstall™ Fixed Mounts | 47 - 50 Fusion Menu Board Mounts |
| 39 Other Fixed Wall Mounts & Accessories | 51 - 53 ConnexSys™ Video Wall System & Accessories |
| 40 - 44 Fusion Tilt Mounts, ViewShare & Accessories | 54 - 57 Thinstall Swing Arm Mounts & Accessories |
| 45 Thinstall Tilt Mounts | 58 Other Swing Arm Mounts & Accessories |

CEILING DISPLAY MOUNTS

- | | |
|---|---|
| 59 - 65 Fusion Ceiling Mounts | 70 - 72 Ceiling Display Mount Accessories |
| 66 - 67 Fusion Video Wall Mounts | 73 - 74 Other Ceiling, Truss & Pole Mounts & Accessories |
| 68 - 69 Fusion Menu Board Mounts | |

TABLE OF CONTENTS

FREESTANDING DISPLAY MOUNTS

75 - 82 Fusion Video Wall Mounts & Accessories

83 - 84 Fusion Carts & Stands

85 Fusion Dynamic Height Adjust Cart & Stands

86 - 87 Fusion Cart & Stands Accessories

88 - 90 Other Cart & Stand Mounts & Accessories

91 Table Stand Display Mounts

MONITOR MOUNTS

92 - 96 Kontour™ K1 Dynamic Height Adjust Desk Mounts & Accessories

97 - 99 Kontour K2 Desk Mounts & Accessories

100 - 103 Kontour K3 Static Desk Arrays & Accessories

104 - 107 Kontour K4 Depth-Adjustable Desk Arrays & Accessories

108 - 110 Kontour K1 Series Wall Mounts & Accessories

111 Kontour K2 Series Wall Mounts & Accessories

112 Other Kontour Wall Mounts

113 Kontour K4 Series Wall Mounts

















114 Kontour K1 Series Pole Mounts



115 Kontour K2 Series Pole Mounts

116 Other Kontour Pole Mount

QUICK REFERENCE CHART







 = QUALIFIES FOR LEED CREDIT









CEILING PROJECTOR MOUNTS						
Model	Product	Weight Capacity	Roll, Pitch, and Yaw	Dimensions (HxWxD)	Color	Page
KITEC030045		11.3 kg	3°, 15°, 20°	144 x 144 x 535 mm	Ⓜ Ⓟ	19
KITEC045080		11.3 kg	3°, 15°, 20°	144 x 144 x 885 mm	Ⓜ Ⓟ	19
KITEC080135		11.3 kg	3°, 15°, 20°	144 x 144 x 1435 mm	Ⓜ Ⓟ	19
KITMC030045		22.7 kg	3°, 15°, 20°	144 x 144 x 535 mm	Ⓜ Ⓟ	?
KITMC045080		22.7 kg	3°, 15°, 20°	144 x 144 x 885 mm	Ⓜ Ⓟ	?
KITMC080135		22.7 kg	3°, 15°, 20°	144 x 144 x 1435 mm	Ⓜ Ⓟ	?
RMAU RPA ELITE [®] SERIES		22.7 kg	3°, 20°, 360°	69 x 165 x 140 mm	Ⓜ Ⓟ	20
RMAU RPA ELITE [®] SERIES		11.3 kg	3°, 15°, 360°	46 x 111 x 129 mm	Ⓜ Ⓟ	20
RPAU RPA SERIES	 	22.7 kg	4°, 25°, 360°	44 x 165 x 140 mm	Ⓜ Ⓟ	21
RSAU RPA SERIES	 	11.3 kg	3°, 20°, 360°	37 x 111 x 112 mm	Ⓜ Ⓟ	21
SYSAUW		15.9 kg	+/-3°, +/-10°, +/-10°	See product page	Ⓜ	22
KITMZ006S		11.3 kg	3°, 15°, 360°	—	Ⓢ	22
VCMU		113.4 kg	5°, 20°, 360°	97 x 432 x 235 mm	Ⓜ Ⓟ	23
VPAU		34 kg	±95°, 360°, 360°	140 x 152 x 178 mm	Ⓜ Ⓟ	23

AUTOMATED PROJECTOR MOUNTS							
Model	Product	Extension	Weight Capacity	Max Projector Size (HxWxD)	Ceiling Opening (HxWxD)	Ceiling Closure (WxD)	Page
SL220 SMART-LIFT		216 mm	13.6 kg	241 x 419 x 470 mm	284 x 597 x 597 mm	489 x 526 mm	28
SL236i SMART-LIFT		914 mm	15.9 kg	235 x 521 x 578 mm	282 x 648 x 724 mm	607 x 607 mm	28
SL151i SMART-LIFT		211 mm	15.9 kg	213 x 464 x 464 mm	284 x 597 x 597 mm	514 x 515 mm	28

QUICK REFERENCE CHART

 = QUALIFIES FOR LEED CREDIT



WALL PROJECTOR MOUNTS							
Model	Product	Extension	Weight Capacity	Pitch	Lateral Shift	Dimensions (HxWxD)	Page
WM210AUS WM SERIES		S EXTENDS UP TO 495 mm	11.3 kg	±3°	330 mm	293 x 499 x 586 mm	30
WM220AUS WM SERIES		M EXTENDS UP TO 768 mm	11.3 kg	±3°	330 mm	293 x 499 x 904 mm	30
WM230AUS WM SERIES		L EXTENDS UP TO 1,384 mm	11.3 kg	±3°	330 mm	290 x 500 x 1510 mm	30
WM110AUS WM SERIES		S EXTENDS UP TO 457 mm	11.3 kg	±3°	N/A	360 x 185 x 551 mm	30
WM120AUS WM SERIES		M EXTENDS UP TO 724 mm	11.3 kg	±3°	N/A	360 x 185 x 869 mm	30
WM130AUS WM SERIES		L EXTENDS UP TO 1,334 mm	11.3 kg	±3°	N/A	360 x 185 x 1479 mm	30
WP21US WPSERIES		S EXTENDS UP TO 562 mm	11.3 kg	±3°	44 mm	220 x 480 x 620 mm	31
WP22US WPSERIES		M EXTENDS UP TO 968 mm	11.3 kg	±3°	44 mm	220 x 480 x 1030 mm	31
WP23US WPSERIES		L EXTENDS UP TO 1,375 mm	11.3 kg	±3°	44 mm	220 x 480 x 1430 mm	31



































FIXED DISPLAY WALL MOUNTS									
Model	Product	Screen Size	Weight Capacity	Dimensions (HxWxD)	Mounting Patterns (W,H)	Max Lateral Shift	Height Adjust	Page	
XSM1U FUSION SERIES		XL 55 - 90"	113.4 kg	667 x 1086 x 57 mm	100 x 100 - 1070 x 600 mm	543 mm	25 mm	33	
LSM1U FUSION SERIES		L 37 - 80"	90.7 kg	464 x 883 x 51 mm	100 x 100 - 871 x 500 mm	441 mm	25 mm	33	
LSA1U FUSION SERIES		L 37 - 80"	90.7 kg	455 x 883 x 51 mm	100 x 100 - 870 x 500 mm	441 mm	N/A	33	
MSM1U FUSION SERIES		M 32 - 47"	56.7 kg	464 x 654 x 51 mm	100x 100 - 642 x 400 mm	327 mm	25 mm	34	
MSA1U FUSION SERIES		M 32 - 47"	56.7 kg	455 x 654 x 51 mm	100 x 100 - 642 x 400 mm	327 mm	N/A	34	
LSD1U FUSION SERIES		L 57 - 80 kg	57 - 80 kg	635 x 884 x 130 mm	200 x 200 - 800 x 400 mm	N/A	400 mm	35	
MSD1U FUSION SERIES		M 31 - 60 kg	31 - 60 kg	635 x 884 x 130 mm	200 x 200 - 800 x 400 mm	N/A	400 mm	35	
LSTU THINSTALL™ SERIES		L 37 - 63"	56.7 kg	628 x 907 x 10 mm	200 x 200 - 800 x 500 mm	N/A	N/A	38	
MSTU THINSTALL SERIES		M 26 - 47"	56.7 kg	530 x 706 x 10 mm	100 x 100 - 600 x 400 mm	N/A	N/A	38	





QUICK REFERENCE CHART

 = QUALIFIES FOR LEED CREDIT











FIXED DISPLAY WALL MOUNTS								
Model	Product	Screen Size	Weight Capacity	Dimensions (HxWxD)	Mounting Patterns (W,H)	Max Lateral Shift	Height Adjust	Page
PSMH MULTIPLE MODELS				Varies per model. See product page.				39
FSR1U		 10 - 32"	20.4 kg	178 x 152 x 18 mm	50 x 50 - 200 x 200 mm	N/A	N/A	39









TILT DISPLAY WALL MOUNTS								
Model	Product	Screen Size	Weight Capacity	Dimensions (HxWxD)	Mounting Patterns (W,H)	Max Lateral Shift	Tilt	Page
XTM1U FUSION™ SERIES	 	 55 - 90"	113.4 kg	622 x 1086 x 64 mm	100 x 100 - 1070 x 600 mm	542 mm	+5°, -12°	41
LTM1U FUSION SERIES	 	 37 - 80"	90.7 kg	432 x 883 x 51 mm	100 x 100 - 878 x 500 mm	441 mm	+2°, -12°	41
LTA1U FUSION SERIES	 	 37 - 80"	90.7 kg	419 x 883 x 51 mm	100 x 100 - 875 x 500 mm	441 mm	+2°, -12°	41
MTM1U FUSION SERIES	 	 32 - 55"	56.7 kg	432 x 654 x 51 mm	100 x 100 - 650 x 400 mm	327 mm	+2°, -12°	42
MTMP1U FUSION SERIES	 	 45 - 55"	56.7 kg	622 x 530 x 81 mm	100 x 100 - 600 x 570 mm	265 mm	+5°, -12°	42
MTA1U FUSION SERIES	 	 32 - 55"	56.7 kg	419 x 654 x 51 mm	100 x 100 - 650 x 400 mm	327 mm	+2°, -12°	42
MTMS1U FUSION SERIES	 	 32 - 47"	34 kg	359 x 463 x 51 mm	200 x 200 - 450 x 400 mm	N/A	+2°, -12°	43
STMS1U FUSION SERIES	 	 24 - 32"	34 kg	359 x 362 x 51 mm	75 x 75 - 300 x 300 mm	N/A	+2°, -12°	43
LTTU THINSTALL™ SERIES		 37 - 80"	45.4 kg	548 x 907 x 19 mm	200 x 200 - 800 x 500 mm	N/A	-12°	45
MTTU THINSTALL SERIES		 26 - 55"	45.4 kg	448 x 706 x 19 mm	100 x 100 - 600 x 400 mm	N/A	-12°	45
ODMLT		 32 - 80"	79.3 kg	457 x 737 x 83 mm	127 x 100 - 643 x 430 mm	51 mm	±15°	46
MWCU		 26 - 55"	45.4 kg	303 x 487 x 114 mm	100 x 100 - 709 x 431 mm	N/A	-15°	46
FTR1U		 10 - 32"	20.4 kg	162 x 147 x 48 mm	50 x 50 - 200 x 200 mm	N/A	+5°, -15°	46















MENU BOARD DISPLAY WALL MOUNTS								
Model	Product	Screen Size	Weight Capacity	Dimensions (HxWxD)	Mounting Patterns (W,H)	Depth Adjust	Tilt	Page
LWMSX1U		 40 - 55"	56.7 kg	43 x 490 x 15 cm	any width x 100-400 mm	147-173 mm	20°	48

QUICK REFERENCE CHART

 = QUALIFIES FOR LEED CREDIT

MENU BOARD DISPLAY WALL MOUNTS								
Model	Product	Screen Size	Weight Capacity	Dimensions (HxWxD)	Mounting Patterns (W,H)	Depth Adjust	Tilt	Page
LWM4X1U		 40 - 55"	56.7 kg	43 x 399 x 15 cm	any width x 100-400 mm	147-173 mm	20°	48
LWM3X1U		 40 - 55"	56.7 kg	43 x 276 x 15 cm	any width x 100-400 mm	147-173 mm	20°	48
LWM3X1UP		 40 - 55"	56.7 kg	43 x 175 x 15 cm	any width x 100-400 mm	147-173 mm	20°	49
LWM2X1U		 40 - 55"	56.7 kg	43 x 183 x 15 cm	any width x 100-400 mm	147-173 mm	20°	49
LWM2X1UP		 40 - 55"	56.7 kg	43 x 119 x 15 cm	any width x 100-400 mm	147-173 mm	20°	49







VIDEO WALL DISPLAY									
Model	Product	Screen Size	Weight Capacity (per screen)	Dimensions (HxWxD)	Mounting Patterns (WxH)	Tilt	Height Adjust	Total Depth Adjust	Page
LVS1U CONNEXSYS™ SERIES		 42 - 80"	68 kg	531 x 903 x 101 mm	200 x 100 - 700 x 400 mm	+4°/-2.5°	± 25 mm	85 mm	52
LVS1UP CONNEXSYS SERIES		 40 - 80"	68 kg	826 x 496 x 104 mm	200 x 100 - 800 x 400 mm	+4°/-2.5°	± 25 mm	85 mm	52
LVSXU CONNEXSYS SERIES		 42 - 80"	68 kg	554 x 903 x 102 mm	200 x 100 - 700 x 400 mm	+4°/-2.5°	± 25 mm	85 mm	52
LVSXUP CONNEXSYS SERIES		 40 - 80"	68 kg	826 x 496 x 104 mm	200 x 100 - 800 x 400 mm	+4°/-2.5°	± 25 mm	85 mm	52































SWING ARM DISPLAY WALL MOUNTS								
Model	Product	Screen Size	Weight Capacity (per screen)	Dimensions (HxWxD)	Mounting Patterns (W,H)	Max Lateral Shift	Extension	Page
TS525TU THINSTALL™ SERIES		 37 - 58"	56.7 kg	527 x 749 x 38 mm	100 x 100 - 800 x 400 mm	635 mm	406 mm	55
TS325TU THINSTALL SERIES		 26 - 52"	34 kg	439 x 749 x 46 mm	100 x 100 - 600 x 400 mm	635 mm	406 mm	55
TS318TU THINSTALL SERIES		 26 - 52"	34 kg	439 x 574 x 46 mm	100 x 100 - 600 x 400 mm	457 mm	406 mm	55
TS318SU THINSTALL SERIES		 26 - 52"	34 kg	343 x 574 x 46 mm	100 x 100 - 600 x 400 mm	457 mm	N/A	55
TS218SU THINSTALL SERIES		 26 - 47"	34 kg	356 x 330 x 38 mm	100 x 100 - 400 x 400 mm	457 mm	N/A	56
TS118SU THINSTALL SERIES		 10 - 32"	15.9 kg	294 x 330 x 38 mm	75 x 75 - 200 x 200 mm	457 mm	N/A	56
TS110SU THINSTALL SERIES		 10 - 32"	15.9 kg	239 x 356 x 38 mm	75 x 75 - 200 x 200 mm	250 mm	N/A	56



QUICK REFERENCE CHART











 = QUALIFIES FOR LEED CREDIT





SWING ARM DISPLAY WALL MOUNTS								
Model	Product	Screen Size	Weight Capacity (per screen)	Dimensions (HxWxD)	Mounting Patterns (W,H)	Max Lateral Shift	Extension	Page
PDRUB		 42 - 80"	90.7 kg	560 x 1003 x 86 mm	200 x 200 - 862 x 517 mm	940 mm	229 mm	58
PNRUB		 42 - 80"	90.7 kg	538 x 687 x 84 mm	200 x 200 - 862 x 517 mm	635 mm	229 mm	58
ODMLA25		 32 - 80"	68 kg	470 x 748 x 124 mm	75 x 75 - 709 x 444 mm	N/A	508 mm	58

CEILING DISPLAY MOUNTS								
Model	Product	Screen Size	Configuration	Weight Capacity (per screen)	Dimensions (HxWxD)	Mounting Patterns (W,H)	Tilt	Page
XCM1U FUSION SERIES		 60 - 90"	Single Landscape	113.4 kg	425 x 884 x 201 mm	200 x 100 - 800 x 400 mm	+5°, -20°	60
XCM7000 FUSION SERIES		 60 - 98"	Single Landscape	136 kg	425 x 884 x 203 mm	200 x 100 - 800 x 400 mm	+7.5°/-20°	60
LCM1U FUSION SERIES		 45 - 70"	Single Landscape	56.7 kg	420 x 681 x 162 mm	200 x 100 - 616 x 400 mm	+5°, -20°	60
LCM1UP FUSION SERIES		 45 - 70"	Single Portrait	56.7 kg	826 x 529 x 162 mm	200 x 100 - 460 x 800 mm	+5°, -20°	61
MCM1U FUSION SERIES		 32 - 55"	Single Landscape or Portrait	56.7 kg	420 x 529 x 162 mm	200 x 100 - 460 x 400 mm	+5°, -20°	61
XCB1U FUSION SERIES		 60 - 90"	Back-to-Back Landscape	90.7 kg	425 x 884 x 296 mm	200 x 100 - 800 x 400 mm	+5°, -20°	61
XCB7000 FUSION SERIES		 60 - 90"	Back-to-Back Landscape	136 kg	425 x 884 x 300 mm	200 x 100 - 800 x 400mm	+7.5°/-20°	62
LCB1U FUSION SERIES		 45 - 70"	Back-to-Back Landscape	56.7 kg	420 x 681 x 259 mm	200 x 100 - 616 x 400 mm	+5°, -20°	62
MCB1U FUSION SERIES		 32 - 55"	Back-to-Back Landscape	56.7 kg	419 x 529 x 259 mm	200 x 100 - 460 x 400 mm	+5°, -20°	62
LCM1X2U FUSION SERIES		 45 - 60"	1 wide x 2 tall Single-Sided Landscape	56.7 kg	420 x 681 x 162 mm	200 x 100 - 616 x 400 mm	+5°, -20°	63
MCM1X2U FUSION SERIES		 32 - 50"	1 wide x 2 tall Single-Sided Landscape	56.7 kg	419 x 529 x 162 mm	200 x 100 - 460 x 400 mm	+5°, -20°	63
LCB1X2U FUSION SERIES		 45 - 60"	1 wide x 2 tall Back-to-Back Landscape	45.3 kg	420 x 681 x 259 mm	200 x 100 - 616 x 400 mm	+5°, -20°	63
MCB1X2U FUSION SERIES		 45 - 50"	1 wide x 2 tall Back-to-Back Landscape	45.3 kg	420 x 529 x 259 mm	200 x 100 - 460 x 400 mm	+5°, -20°	64
LCM4U FUSION SERIES		 45 - 65"	Quad Mount	38 kg	475 x 1422 x 1422 mm	200 x 200 - 600 x 400 mm	+5°, -20°	64
LCM3U FUSION SERIES		 45 - 65"	Triple Mount	57 kg	462 x 1184 x 1184 mm	200 x 200 - 600 x 400 mm	+5°, -20°	64

QUICK REFERENCE CHART

 = QUALIFIES FOR LEED CREDIT

VIDEO WALL DISPLAY CEILING MOUNTS							
Model	Product	Screen Size	Configuration	Weight Capacity (per screen)	Dimensions (HxWxD)	Mounting Patterns (W,H)	Page
LCM2X2U FUSION SERIES		 40 - 55"	2 wide x 2 tall Landscape	56.7 kg	1389 x 1851 x 368 mm	Any Width x 100 - 400 mm	66
LCM2X2UP FUSION SERIES		 40 - 55"	2 wide x 2 tall Portrait	56.7 kg	1996 x 1189 x 368 mm	Any Width x 100 - 800 mm	66
LCM3X2U FUSION SERIES		 40 - 55"	3 wide x 2 tall Landscape	56.7 kg	1389 x 2766 x 368 mm	Any Width x 100 - 400 mm	67
LCM3X2UP FUSION SERIES		 40 - 55"	3 wide x 2 tall Portrait	56.7 kg	1996 x 1748 x 368 mm	Any Width x 100 - 800 mm	67
LCM3X3U FUSION SERIES		 40 - 55"	3 wide x 3 tall Landscape	38.5 kg	1996 x 2763 x 368 mm	Any Width x 100 - 400 mm	67





























MENU BOARD DISPLAY CEILING MOUNTS								
Model	Product	Screen Size	Configuration	Weight Capacity (per screen)	Dimensions (HxWxD)	Mounting Patterns (W,H)	Micro Height Adjust	Page
LCM2X1U FUSION SERIES		 40 - 55"	2 wide Landscape	56.7 kg	427 x 1851 x 201 mm	Any Width x 100 - 400 mm	N/A	68
LCM2X1UP FUSION SERIES		 40 - 55"	2 wide Portrait	56.7 kg	826 x 1190 x 201 mm	Any Width x 100 - 800 mm	N/A	68
LCM3X1U FUSION SERIES		 40 - 55"	3 wide Landscape	56.7 kg	425 x 2766 x 201 mm	Any Width x 100 - 400 mm	51 mm	69
LCM3X1UP FUSION SERIES		 40 - 55"	3 wide Portrait	56.7 kg	826 x 175 x 201 mm	Any Width x 100 - 800 mm	51 mm	69
LCB2X1U FUSION SERIES		 40 - 55"	2 wide Back-to-Back Landscape	45.4 kg	425 x 1851 x 296 mm	Any Width x 100 - 400 mm	N/A	69
LCB2X1UP FUSION SERIES		 40 - 55"	2 wide Back-to-Back Portrait	45.4 kg	826 x 1190 x 296 mm	Any Width x 100 - 800 mm	N/A	65
LCB3X1U FUSION SERIES		 40 - 55"	3 wide Back-to-Back Landscape	56.7 kg	425 x 2763 x 292 mm	Any Width x 100 - 400 mm	51 mm	65
LCB3X1UP FUSION SERIES		 40 - 55"	3 wide Back-to-Back Portrait	56.7 kg	826 x 1748 x 292 mm	Any Width x 100 - 800 mm	51 mm	65



QUICK REFERENCE CHART



 = QUALIFIES FOR LEED CREDIT



CEILING DISPLAY MOUNTS							
Model	Product	Screen Size	Weight Capacity	Dimensions (HxWxD)	Mounting Patterns (W,H)	Tilt	Page
TPSU		 42 - 71"	68 kg	412 x 433 x 27 mm	200 x 200 - 862 x 517 mm	N/A	73
TPMU		 42 - 71"	68 kg	412 x 433 x 86 mm	200 x 200 - 862 x 517 mm	+5°, -15°	73
JPPU		 26 - 45"	34 kg	189 x 152 x 89 mm	100 x 100 - 400 x 400 mm	±15°	73
KOP100B		 10 - 30"	18.14 kg	192 x 114 x 66 mm	75 x 75 - 100 x 100 mm	+75°, -10°	73





FREESTANDING VIDEO WALL DISPLAY MOUNTS								
Model	Product	Screen Size	Configuration	Weight Capacity (per screen)	Dimensions (HxWxD)	Mounting Patterns (W,H)	Height Adjust (per screen)	Page
LVM3X3U FUSION SERIES		 42 - 46"	3 wide x 3 tall Freestanding Landscape	45.4 kg	2350 x 2743 x 1026 mm	Any Width x 100 - 400 mm	19 mm	76
LBM3X3U FUSION SERIES		 42 - 46"	3 wide x 3 tall Bolt-down Landscape	45.4 kg	2310 x 2763 x 239 mm	Any Width x 100 - 400 mm	19 mm	76
LVM3X2U FUSION SERIES		 42 - 46"	3 wide x 2 tall Freestanding Landscape	56.7 kg	1893 x 2743 x 1026 mm	Any Width x 100 - 400 mm	19 mm	76
LVM3X2UP FUSION SERIES		 42 - 46"	3 wide x 2 tall Freestanding Portrait	45.4 kg	2710 x 1727 x 1026 mm	100 - 800 mm x Any Height	19 mm	76
LBM3X2U FUSION SERIES		 42 - 46"	3 wide x 2 tall Bolt-down Landscape	56.7 kg	1852 x 2766 x 239 mm	Any Width x 100 - 400 mm	19 mm	77
LBM3X2UP FUSION SERIES		 42 - 46"	3 wide x 2 tall Bolt-down Portrait	45.4 kg	2504 x 1727 x 244 mm	100 - 800 mm x Any Height	19 mm	77
LVM3X1UP FUSION SERIES		 42 - 46"	3 wide x 1 tall Freestanding Portrait	56.7 kg	2253 x 1727 x 1026 mm	100 - 800 mm x Any Height	19 mm	77
LBM3X1UP FUSION SERIES		 42 - 46"	3 wide x 1 tall Bolt-down Portrait	56.7 kg	2047 x 1727 x 244 mm	100 - 800 mm x Any Height	19 mm	77
LBM1X3U FUSION SERIES		 42 - 65"	1 wide x 3 tall Bolt-down Landscape	56.7 kg	2145 x 914 x 191 mm	100 x 100 - 900 x 400 mm	19 mm	78
LVM2X2U FUSION SERIES		 42 - 50"	2 wide x 2 tall Freestanding Landscape	56.7 kg	2045 x 1842 x 1026 mm	Any Width x 100 - 400 mm	19 mm	78
LVM2X2UP FUSION SERIES		 42 - 50"	2 wide x 2 tall Freestanding Portrait	45.4 kg	2710 x 1168 x 1026 mm	100 - 800 mm x Any Height	19 mm	78
LBM2X2U FUSION SERIES		 42 - 50"	2 wide x 2 tall Bolt-down Landscape	56.7 kg	1852 x 1852 x 239 mm	Any Width x 100 - 400 mm	19 mm	78
LBM2X2UP FUSION SERIES		 42 - 50"	2 wide x 2 tall Bolt-down Portrait	45.4 kg	2504 x 1168 x 240 mm	100 - 800 mm x Any Height	19 mm	79
LBM1X2U FUSION SERIES		 42 - 80"	1 wide x 2 tall Bolt-down Landscape	56.7 kg	1689 x 914 x 191 mm	100 x 100 - 900 x 400 mm	19 mm	79





QUICK REFERENCE CHART

 = QUALIFIES FOR LEED CREDIT

FREESTANDING VIDEO WALL DISPLAY MOUNTS								
Model	Product	Screen Size	Configuration	Weight Capacity (per screen)	Dimensions (HxWxD)	Mounting Patterns (W,H)	Height Adjust (per screen)	Page
LBM1X2UP FUSION SERIES		L 42 - 80"	1 wide x 2 tall Bolt-down Portrait	56.7 kg	2145 x 914 x 191 mm	100 x 100 mm - 800 x 900 mm	19 mm	79
XBM1U FUSION SERIES		XL 42 - 80"	1 wide x 1 tall, Bolt-down, Landscape	113 kg	2143 x 914 x 191 mm	100 x 100 mm - 900 x 400 mm	19 mm	79
XBM1UP FUSION SERIES		XL 42 - 80"	1 wide x 1 tall, Bolt-down, Portrait	113 kg	2083 x 914 x 191 mm	100 x 100 mm - 800 x 900 mm	19 mm	80

FREESTANDING DISPLAY MOUNTS								
Model	Product	Screen Size	Weight Capacity	Dimensions (HxWxD)	Mounting Patterns (W,H)	Center of Display to Floor Range	Tilt	Page
XVAU FUSION SERIES		XL 37 - 70"	113 kg	1395 x 986 x 737 mm	200 x 200 - 800 x 400 mm	1064 - 1280 mm	±2.5°	83
XPA1U FUSION SERIES		XL 55 - 100"+	136 kg	1877 x 1472 x 878 mm	200 x 200 - 800 x 400 mm	1213 - 1662 mm	N/A	83

Model	Product	Screen Size	Weight Capacity	Dimensions (HxWxD)	Mounting Patterns (W,H)	Center of Display to Floor Range	Tilt	Page
XFA1U FUSION SERIES		XL 55 - 100"+	136 kg	1738 x 936 x 226 mm	200 x 200 - 800 x 400 mm	1066 - 1515 mm	N/A	83
LPAU FUSION SERIES		L 40 - 80"	90.7 kg	1801 x 1143 x 844 mm	200 x 200 - 800 x 400 mm	1271 - 1779 mm	±5°	84
LFAU FUSION SERIES		L 40 - 80"	90.7 kg	1839 x 968 x 777 mm	200 x 200 - 800 x 400 mm	1130 - 1640 mm	±5°	84
MPAU FUSION SERIES		M 37 - 55"	56.7 kg	1979 x 1214 x 813 mm	200 x 100 - 600 x 400 mm	1270 - 1770 mm	±5°	84
MFAU FUSION SERIES		M 37 - 55"	56.7 kg	1839 x 968 x 777 mm	200 x 100 - 600 x 400 mm	1130 - 1630 mm	±5°	84

Model	Product	Screen Size	Weight Capacity	Dimensions (HxWxD)	Mounting Patterns (W,H)	Travel Range Options	Page
LPD1U FUSION SERIES		L	57 - 80 kg	1753 x 1471 x 876 mm	200 x 200 - 800 x 400 mm	92.3 - 137.2 cm; 105 - 144.5 cm; 112.5 - 152.4 cm; 120.1 - 160 cm; 127.8 - 167.6 cm	85
MPD1U FUSION SERIES		M	30 - 59 kg	1753 x 1471 x 876 mm	200 x 200 - 800 x 400 mm	92.3 - 137.2 cm; 105 - 144.5 cm; 112.5 - 152.4 cm; 120.1 - 160 cm; 127.8 - 167.6 cm	85
LFD1U FUSION SERIES		L	56 - 79 kg	1636 x 935 x 160 mm	200 x 200 - 800 x 400 mm	82.6 - 122.4 cm; 90.2 - 130 cm; 97.8 - 137.3 cm; 105.4 - 145.3 cm; 113 - 152.9 cm	85
MFD1U FUSION SERIES		M	30 - 59 kg	1636 x 935 x 160 mm	200 x 200 - 800 x 400 mm	82.6 - 122.4 cm; 90.2 - 130 cm; 97.8 - 137.3 cm; 105.4 - 145.3 cm; 113 - 152.9 cm	85



QUICK REFERENCE CHART

 = QUALIFIES FOR LEED CREDIT







































FREESTANDING DISPLAY MOUNTS								
Model	Product	Screen Size	Weight Capacity	Dimensions (HxWxD)	Mounting Patterns (W,H)	Center of Display to Floor Range	Tilt	Page
XVM1U		 65"+	140.6 kg	1940 x 2312 x 1057 mm	1200, 1100, 1000, 900, 800, 700, 600, 500, 400 x 600 or 400 mm	N/A	N/A	88
PFCU		 42 - 60"	90.7 kg	2073 x 943 x 816 mm	200 x 200 - 862 x 517 mm	1220 - 1830 mm	±15°	88
PFIU		 42 - 60"	90.7 kg	2388 x 914 x 762 mm	200 x 200 - 862 x 517 mm	1300 - 2170 mm	±15°	88
MFCU		 30 - 55"	56.7 kg	1975 x 943 x 816 mm	100 x 100 - 709 x 431 mm	1220 - 1830 mm	±15°	88
MFIU		 30 - 55"	56.7 kg	2327 x 914 x 762 mm	100 x 100 - 709 x 431 mm	1300 - 2180 mm	±15°	89
MPAUBSP		 30 - 55"	56.7 kg	2170 x 1088 x 978 mm	200 x 200 - 200 x 800 mm	1270 - 1770 mm	±5°	89
MFAUBSP		 30 - 55"	56.7 kg	2038 x 967 x 771 mm	200 x 200 - 200 x 800 mm	1131 - 1639 mm	±5°	89
PRSU		 42 - 60"	90.7 kg	2034 x 913 x 851 mm	200 x 200 - 860 x 515 mm	1142 - 1828 mm	±15°	89

TABLE STAND DISPLAY MOUNTS								
Model	Product	Screen Size	Weight Capacity	Dimensions (HxWxD)	Mounting Patterns (W,H)	Height Adjust	Swivel Options	Page
STLU		 32 - 52"	56.7 kg	603 x 698 x 140 mm	100 x 100 - 600 x 400 mm	N/A	15°, 30°, 45° or 90°	91
PTSU		 30 - 50"	45.4 kg	545 x 607 x 278 mm	200 x 200 - 860 x 515 mm	102 mm	N/A	91
STS1		 18 - 32"	13.6 kg	409 x 152 x 175 mm	75 x 75 - 100 x 100 mm	130 mm	90°, 180°, 270°	91

DESK MONITOR MOUNTS							
Model	Product	Minimum Depth from Back of Desk	Maximum Extension	Weight Capacity (per monitor)	Colors	Page	
K1C220 KONTOUR™ SERIES		62 mm	523 mm	2.3 - 11.3 kg (per monitor)	 	93	
K1C210 KONTOUR SERIES		62 mm	352 mm	2.3 - 11.3 kg (per monitor)	 	93	
K1C22H KONTOUR SERIES		156 mm	587 mm	0.9 - 4.08 kg		93	
K1C120 KONTOUR SERIES		62 mm	571 mm	2.3 - 9.9 kg	 	93	
K1C330 KONTOUR SERIES		62 mm	648 mm	2.3 - 9.07 kg	 	93	

QUICK REFERENCE CHART

 = QUALIFIES FOR LEED CREDIT















DESK MONITOR MOUNTS						
Model	Product	Minimum Depth from Back of Desk	Maximum Extension	Weight Capacity (per monitor)	Colors	Page
K1C420 KONTOUR SERIES		62 mm	648 mm	2.3 - 9.07 kg	W B	93
K1C110 KONTOUR SERIES		62 mm	400 mm	2.3 - 11.3 kg	S B	94
K1D220 KONTOUR SERIES		62 mm	548 mm	2.3 - 11.3 kg	W B	94
K1D22H KONTOUR SERIES		109 mm	538 mm	0.9 - 4.08 kg	B	94
K1D120 KONTOUR SERIES		62 mm	523 mm	2.3 - 11.3 kg	W B S	95
Model	Product	Minimum Depth from Back of Desk	Maximum Extension	Weight Capacity (per monitor)	Colors	Page
K2C220 KONTOUR SERIES		105 mm	448 mm	11.3 kg	S B	97
K2C22H KONTOUR SERIES		156 mm	499 mm	4.08 kg (per monitor)	B	97
K2C120 KONTOUR SERIES		152 mm	495 mm	18.1 kg	S B	98
K2C110 KONTOUR SERIES		152 mm	324 mm	18.1 kg	S B	98

(Silver displays shown with Apple® Cinema Display adapter, not included.)



QUICK REFERENCE CHART

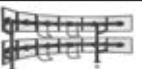
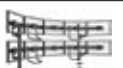
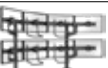









 = QUALIFIES FOR LEED CREDIT

DESK MONITOR MOUNTS								
Model	Product	Center of Display to Floor/Table Range	Maximum Width (per monitor)	Minimum Depth	Typical Screen Size	Weight Capacity (per monitor)	Color	Page
K3F220B KONTOUR™ SERIES		460 mm	736 mm	±12°	10 - 27"	6.8 kg	B	101
K3G220B KONTOUR SERIES		460 mm	736 mm	±12°	10 - 27"	6.8 kg	B	101
K3G320B KONTOUR SERIES		460 mm	2 x 2: 1301 mm 3 x 2: 650 mm	Outer - ±12° Center - ±10°	10 - 30"	6.8 kg	B	101
K3F310B KONTOUR SERIES		N/A	Dual: 1301 mm Triple: 650 mm	Outer - ±12° Center - ±10°	Dual: up to 30" Triple: up to 27"	6.8 kg	B	102
K3G310B KONTOUR SERIES		N/A	Dual: 1301 mm Triple: 650 mm	Outer - ±12° Center - ±10°	Dual: up to 30" Triple: up to 27"	6.8 kg	B	102
K3F120B KONTOUR SERIES		460 mm	N/A	±10°	10 - 30"	6.8 kg	B	102
K3G120B KONTOUR SERIES		460 mm	N/A	±10°	10 - 30"	6.8 kg	B	102
K4G610B KONTOUR SERIES		291 - 463 mm	614 mm	815 mm	up to 24"	6.8 kg	B	104
K4G510B KONTOUR SERIES		291 - 463 mm	614 mm	592 mm	up to 24"	6.8 kg	B	104
K4G410B KONTOUR SERIES		291 - 463 mm	614 mm	396 mm	up to 24"	6.8 kg	B	105
K4G310B KONTOUR SERIES		291 - 463 mm	614 mm	239 mm	up to 24"	6.8 kg	B	105
K4G210B KONTOUR SERIES		291 - 463 mm	943 mm	239 mm	up to 24"	6.8 kg	B	105
K4G120B KONTOUR SERIES		291 - 463 mm	406 mm	239 mm	up to 24"	6.8 kg	B	105
K4G620B KONTOUR SERIES		269 - 1107 mm	584 mm	815 mm	up to 24"	6.8 kg	B	106
K4G520B KONTOUR SERIES		269 - 1107 mm	584 mm	592 mm	up to 24"	6.8 kg	B	106
K4G420B KONTOUR SERIES		269 - 1107 mm	584 mm	396 mm	up to 24"	6.8 kg	B	106
K4G320B KONTOUR SERIES		269 - 1107 mm	584 mm	318 mm	up to 24"	6.8 kg	B	106

(Silver displays shown with Apple® Cinema Display adapter, not included.)

QUICK REFERENCE CHART

 = QUALIFIES FOR LEED CREDIT

WALL MONITOR MOUNTS									
Model	Product	Minimum Depth from Wall	Maximum Extension	Tilt	Weight Capacity (per monitor)	Colors	Page		
K1W220 KONTOUR SERIES		62 mm	525 mm	+75°, -10°	2.3 - 11.3 kg	B	109		
K1W120 KONTOUR SERIES		62 mm	512 mm	+75°, -10°	2.3 - 11.3 kg	W B	109		
K1W110 KONTOUR SERIES		62 mm	341 mm	+75°, -10°	2.3 - 11.3 kg	B	109		
K2W120 KONTOUR SERIES		75 mm	437 mm	±15°	18.1 kg	S B	111		
Model	Product	Minimum Depth from Wall	Maximum Extension	Tilt	Weight Capacity	Colors	Page		
KOW100		81 mm	N/A	+75°, -10°	18.1 kg	S B	112		
Model	Product	Max. Monitor Width	Extension	Minimum Depth	Arm Rotation	Typical Screen Size	Tilt	Weight Cap. (per monitor)	Page
K4W310B KONTOUR SERIES		614 mm	412 mm	239 mm	0 - 20°	up to 24"	±12°	6.8 kg	113
K4W210B KONTOUR SERIES		943 mm	412 mm	239 mm	0 - 20°	up to 30"	±12°	6.8 kg	113
K4W120B KONTOUR SERIES		406 mm	412 mm	94 mm	0 - 20°	up to 24"	±10°	6.8 kg	113
POLE MONITOR MOUNTS									
Model	Product	Minimum Depth from Pole	Maximum Extension	Tilt	Weight Capacity (per monitor)	Colors	Page		
K1P220 KONTOUR SERIES		62 mm	510 mm	+75°, -10°	2.3 - 11.3 kg	B	114		
K1P120 KONTOUR SERIES		64 mm	493 mm	+75°, -10°	2.3 - 11.3 kg	S B	114		
K2P120 KONTOUR SERIES		74 mm	422 mm	±15°	18.1 kg	B	115		
Model	Product	Minimum Depth from Pole	Typical Screen Size	Tilt	Weight Capacity	Colors	Page		
KOP100		66 mm	10 - 30"	+75°, -10°	18.1 kg	S B	116		





CEILING PROJECTOR MOUNTS

ELITE® SERIES PROJECTOR MOUNT FEATURES



MICROZONE™ ADJUSTMENTS
Designed with MicroZone Adjustments to make projector registration fast and precise.



CENTRIS® TECHNOLOGY
Enables effortless fingertip positioning and self-adjusts to support different projector weights.



CABLE MANAGEMENT
Route cables through the top of the mount without additional accessories.



QUICK CONNECT/DISCONNECT
Disconnecting maintains registration without affecting pre-set adjustments.



SECURITY
Keyed locking and steel-into-steel locking hardware at all connection points to protect against theft.



MULTIPLE CONNECTION OPTIONS
Mounting options include: CMS threaded column system, 6 mm threaded rods and flush mounting to ceiling.

KITEC030045 ALL-IN-ONE PROJECTOR MOUNT KIT



Chief's projector kits offer convenient flexibility with a super sleek design and even quicker installation. Bundled kit includes:

- RSMAU Mini Elite® Universal Projector Mount
- CPA116 Flat Ceiling Plate
- 300–450 mm Telescoping Column

Weight Capacity	Roll, Pitch and Yaw	Extension	Dimensions (LxWxH)	Colors
11.3 kg	3°, 15°, 20°	300 - 450 mm	144 x 144 x 535 mm	W B



KITEC045080 ALL-IN-ONE PROJECTOR MOUNT KIT



Chief's projector kits offer convenient flexibility with a super sleek design and even quicker installation. Bundled kit includes:

- RSMAU Mini Elite® Universal Projector Mount
- CPA116 Flat Ceiling Plate
- 450–800 mm Telescoping Column

Weight Capacity	Roll, Pitch and Yaw	Extension	Dimensions (LxWxH)	Colors
11.3 kg	3°, 15°, 20°	450 - 800 mm	144 x 144 x 885 mm	W B



KITEC080135 ALL-IN-ONE PROJECTOR MOUNT KIT



Chief's projector kits offer convenient flexibility with a super sleek design and even quicker installation. Bundled kit includes:

- RSMAU Mini Elite® Universal Projector Mount
- CPA116 Flat Ceiling Plate
- 800–1350 mm Telescoping Column

Weight Capacity	Roll, Pitch and Yaw	Extension	Dimensions (LxWxH)	Colors
11.3 kg	3°, 15°, 20°	800 - 1350 mm	144 x 144 x 1435 mm	W B



KITMC030045 ALL-IN-ONE PROJECTOR MOUNT KIT



Chief's projector kits offer convenient flexibility with a super sleek design and even quicker installation. Bundled kit includes:

- RPMAU Elite® Universal Projector Mount
- CPA116 Flat Ceiling Plate
- 300–450 mm Telescoping Column

Weight Capacity	Roll, Pitch and Yaw	Extension	Dimensions (LxWxH)	Colors
> 22.7 kg	3°, 15°, 20°	300 – 450 mm	144 x 144 x 535 mm	W B



KITMC045080 ALL-IN-ONE PROJECTOR MOUNT KIT



Chief's projector kits offer convenient flexibility with a super sleek design and even quicker installation. Bundled kit includes:

- RPMAU Elite® Universal Projector Mount
- CPA116 Flat Ceiling Plate
- 450–800 mm Telescoping Column

Weight Capacity	Roll, Pitch and Yaw	Extension	Dimensions (LxWxH)	Colors
> 22.7 kg	3°, 15°, 20°	450 – 800 mm	144 x 144 x 885 mm	W B



KITMC080135 ALL-IN-ONE PROJECTOR MOUNT KIT



Chief's projector kits offer convenient flexibility with a super sleek design and even quicker installation. Bundled kit includes:

- RPMAU Elite® Universal Projector Mount
- CPA116 Flat Ceiling Plate
- 800–1350 mm Telescoping Column

Weight Capacity	Roll, Pitch and Yaw	Extension	Dimensions (LxWxH)	Colors
> 22.7 kg	3°, 15°, 20°	800 – 1350 mm	144 x 144 x 1435 mm	W B



RPMAU ELITE® PROJECTOR MOUNT



Chief's elite ceiling projector mounts are packed with easy-to-use features that save time and provide projector security.

Weight Capacity	Roll, Pitch and Yaw	Dimensions (HxWxD)	Colors
22.7 kg	3°, 20°, 360°	69 x 165 x 140 mm	Ⓜ Ⓟ



RSMAUW MINI ELITE™ PROJECTOR MOUNT



Ideal for smaller projector models, these miniature versions of the Elite mounts include all the same great features in almost half the size.

Weight Capacity	Roll, Pitch and Yaw	Dimensions (HxWxD)	Colors
11.3 kg	3°, 15°, 360°	46 x 111 x 129 mm	Ⓜ Ⓟ



RPA SERIES CEILING MOUNTS FEATURES



INDEPENDENT ADJUSTMENTS
Includes roll, pitch and yaw adjustments for quick and precise projector alignment.



QUICK CONNECT/DISCONNECT
Disconnecting maintains registration without affecting pre-set adjustments.



CABLE MANAGEMENT
Route cables through the top of the mount without additional accessories.



ALL-POINTS SECURITY
Exclusive steel-into-steel locking hardware at all connection points to protect against theft.



MULTIPLE CONNECTION OPTIONS
Mounting options include: CMS threaded column system, 6 mm threaded rods and flush mounting to ceiling.

RPAU PROJECTOR MOUNT



Chief's standard ceiling projector mount is installed in more offices, schools and homes worldwide than any other mount.

Weight Capacity	Roll, Pitch and Yaw	Dimensions (HxWxD)	Colors
22.7 kg	4°, 25°, 360°	44 x 165 x 140 mm	W B

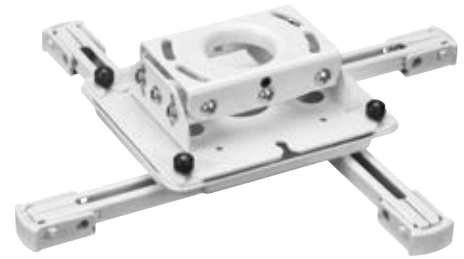

RSAU MINI RPA PROJECTOR MOUNT



Ideal for smaller projector models, these miniature versions of the RPAU mounts include all the same great features in almost half the size.

Weight Capacity	Roll, Pitch and Yaw	Dimensions (HxWxD)	Colors
11.3 kg	3°, 20°, 360°	37 x 111 x 112 mm	W B



SUSPENDED CEILING PROJECTOR MOUNT SYSTEM

FEATURES



ADJUSTABLE CEILING PLATE
Allows flexible placement in standard 60 x 60 cm - 62,5 x 62,5 cm ceiling tile grids



TOOL-FREE ADJUSTMENTS
Tool-Free Microzone and Centris technology make projector registration fast and precise with macro and micro adjustments.



HEIGHT ADJUSTABLE COLUMN
Column instantly adjusts from 0 to 305 mm, eliminating the need to specify column length.



CABLE MANAGEMENT
Separate lay-in channels for high and low voltage cables without additional accessories.



COMPLETE SOLUTION
Single SKU system includes everything required for suspended ceiling mounting and comes out of the box ready to install.

SYSAUW SUSPENDED CEILING PROJECTOR MOUNT SYSTEM



The improved ceiling plate, column system, mount and universal interface of the SYSAU Projector Mount System are designed to cut installation time by one-third.



SYSAUW	Weight Capacity	Overall Dimensions (HxWxD)	Projector Travel from Ceiling	Colors
	15.9 kg	504 x 634 x 184 mm	80 x 374 mm in 13 mm increments	Ⓜ

Mount*	Mount Dimensions (HxWxD)	Roll, Pitch, Yaw
	45 x 178 x 177 mm	±3°, ±10°, ±10°

* Dimensions for mount without column or interface.

Ceiling Plate	Ceiling Plate Dimensions (HxWxD)	Height Adjust	Column Rotation	Column Shift
	117 x 634 x 184 mm	26 mm	360°	234 mm

OTHER

SUSPENDED CEILING KITS

KITMZ006S SUSPENDED CEILING KIT



Weight Capacity	Colors
11.3 kg	Ⓜ

Bundled kit includes:

- RSMAUS Mini Elite® Universal Projector Mount
- CMSZ006S Fully Threaded Extension Column
- CMS440 Lightweight Suspended Ceiling Kit

Fits standard 600 x 600 ceiling tiles.

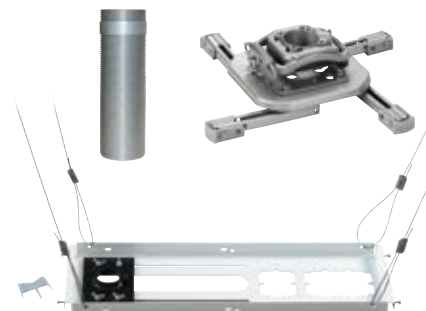

OTHER CEILING PROJECTOR MOUNTS

VCMU HEAVY DUTY MOUNT



Heavy-duty steel mount for mounting heavy projectors.
Micro adjustments allow you to quickly achieve registration.

Weight Capacity	Roll, Pitch and Yaw	Dimensions (HxWxD)	Color
113.4 kg	5°, 20°, 360°	97 x 432 x 235 mm	W B



ACCESSORY



LPK1	Compatibility
Low-Profile Flush Mounting Kit	VCM Series

VPAU FLOOR & PORTRAIT PROJECTOR MOUNT



Enables projectors to be positioned in multiple orientations for portrait and floor projection applications.

Weight Capacity	Roll, Pitch and Yaw	Dimensions (HxWxD)	Color
34 kg	±95°, 360°, 360°	140 x 152 x 178 mm	W B



PROJECTOR MOUNT ACCESSORIES



CMA110	Colors	Weight Capacity
Ceiling Plate - 203 mm	S B	226.8 kg



CMS115	Colors	Weight Capacity
Speed-Connect™ Ceiling Plate	W B	226.8 kg



CMA330	Weight Capacity
Offset Ceiling Plate - 203 mm	226.8 kg



CMA345	Weight Capacity
Structural Ceiling Plate	226.8 kg



CMS380	Weight Capacity
Quick Connect/Disconnect Truss Clamp	226.8 kg



CMA395	Colors	Weight Capacity
Angled Ceiling Plate	B W	226.8 kg



CMA351	Weight Capacity
Heavy Duty Swivel Adapter	226.8 kg



CMA347	Weight Capacity
Vibration Isolating Coupler	15.9 kg



CMA362	Weight Capacity
C-Clamp Adapter	113.4 kg



CMA366	Weight Capacity
Architectural Spanning Adapter	113.4 kg



CMA360	Weight Capacity
I-Beam Clamp	113.4 kg



CMS440	Weight Capacity
Speed-Connect Above-Tile Suspended Ceiling Kit	22.7 kg



CMSZ006	Colors	Weight Capacity
152 mm Fully Threaded Column	S	226.8 kg



CMA640	Compatibility	Colors
Decorative Ring, 48 mm ID	Threaded & CPA Columns	W C B



CMA643	Compatibility
Decorative Ring, 62 mm ID - Silver	CMS Outer Adjustable Columns



CMA340	Weight Capacity
Projector Stabilization Kit	226.8 kg



WMA2S	Weight Capacity
Heavy-Duty Wall Mount Accessory	68 kg (steel stud 34 kg)



WMA1S	Weight Capacity
Heavy-Duty Wall Mount Accessory	68 kg (steel stud 22.7 kg)

PROJECTOR MOUNT ACCESSORIES



CMS Fixed Columns		Weight Capacity	
Fixed 1 1/2" NPT extension columns available in black, silver and white†		500 lbs (226.8 kg)	
Model	Length	Model	Length
CMS003*	3" (76 mm)	CMS024	2' (0.6 m)
CMS006*	6" (152 mm)	CMS036	3' (0.9 m)
CMS009	9" (229 mm)	CMS048	4' (1.2 m)
CMS012	12" (305 mm)	CMS060	5' (1.5 m)
CMS018	18" (457 mm)	CMS072	6' (1.8 m)
† All part numbers listed are black. To order white add a W to the end of the part number.			



CMS Adjustable Columns		Weight Capacity	
Adjustable threaded extension columns available in black and white*		226.8 kg	
Model	Length	Model	Length
CMS006009	152 - 229 mm	CMS0203	0.6 - 0.9 m
CMS009012	229 - 305 mm	CMS0305	0.9 - 1.5 m
CMS012018	305 - 457 mm	CMS0406	1.2 - 1.8 m
CMS018024	457 - 610 mm	CMS0507	1.5 - 2.1 m
* All part numbers listed are black. To order white add a W to the end of the part number.			



CMA274	Colors
Quick-Snap Cable Cover - 1219 mm long	Ⓜ Ⓟ



PG1A	Max Equipment Size (HxWxD)	Colors
Large Projector Guard	191 x 508 x 518 mm	Ⓟ Ⓜ



PG2A	Max Equipment Size (HxWxD)	Colors
Small Projector Guard	191 x 406 x 406 mm	Ⓟ Ⓜ



PG3A	Max Equipment Size (HxWxD)	Colors
Extra Large Projector Guard	288 x 635 x 633 mm	Ⓟ Ⓜ



HC1	Includes
Heavy-Duty Cable system	SA1, cable, padlock, security pads, super glue



LC1	Includes
Security Cable Lock Kit	Coiled cable, padlock, security pads, super glue



SLBLEG	Compatibility	Colors
Universal Projector Leg Accessory	RPA, RPM, RSA and RSM Series	Ⓟ Ⓜ



SEC2	Compatibility
Security Cable Kit for SLBU	RPE, RPME, RSE and RSME Series



LCD2C	Compatibility
Dual Projector Ceiling Stacker	Requires two RPE or RPME projector mounts



LCD2TS	Compatibility
Dual Projector Table Stand Stacker	Requires two RPE or RPME projector mounts



LCDPA	Compatibility
Stacker Arm	RPE and RPME projector mounts



LCDCP	Weight Capacity
Stacker Ceiling Plate	45.4 kg

SUSPENDED CEILING STORAGE SOLUTIONS FEATURES

DROP-DOWN ACCESS

Unique feature lowers the entire frame enough to slide the ceiling tile out of the way for servicing.



PERFECT PLACEMENT

Maximized column location within tile space for less reliance on digital adjustments and lens shift.



CONVENIENT PRELOADING

AV components can be preloaded to shelf before bringing it to the ceiling.





THERMAL MANAGEMENT

Passive cooling vents help with thermal management and an accessory fan is available for active cooling.





	CMS491	Weight Capacity
	Half Tile Plenum Storage Box	45 kg

	CMS491C	Weight Capacity
	Half Tile Plenum Storage Box w/ Column Drop	45 kg

	CMS492	Weight Capacity
	Full Tile Plenum Storage Box	45 kg

	CMS492C	Weight Capacity
	Full Tile Plenum Storage Box w/ Column Drop	45 kg

	CMSFAN	Compatibility
	Plenum Rated Fan Kit	CMS491 & CMS492 Series

	CMS1RU	Compatibility
	1RU Rack Mount Brackets	CMS492 Series

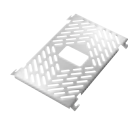
	CMSUNV1	Compatibility	Weight Capacity
	AV Component Shelf	CMS492 Series	11.3 kg



AUTOMATED PROJECTOR MOUNTS

AUTOMATED PROJECTOR MOUNTS FEATURES



QUIET OPERATION

Provides exceptionally smooth and quiet movement, making it a great option for homes and corporate offices.



MULTIPLE CONTROL OPTIONS

Choose from single push-button, low-voltage controller and IR options. Also accepts 5-30V AC/DC for triggering commands. AMX/Crestron control compatibility.



SAFE & SUSTAINABLE

CE, UL, TUV, FC and WEEE certifications recognize safe design and environmentally friendly construction.



MULTIPLE INSTALLATION OPTIONS

Multiple mounting options for finished and suspended ceilings including threaded extension columns, threaded rods and suspension cables.

SL220 SMART-LIFT



Simple 3-step installation process requires only one person. Designed to fit 600 x 600 mm ceiling tiles.



Weight Capacity	Extension	Max Projector Size (HxWxD)	Ceiling Opening (HxWxD)	Ceiling Closure (WxD)
13.6 kg	216 mm	241 x 419 x 470 mm	284 x 597 x 597 mm	489 x 526 mm

RSMAUW projector mount is required. Remote control and IR eye are included.

SL236I SMART-LIFT



Provides 914 mm of downward travel with three stopping positions. Includes adjustments for precise positioning. Order SL236SPI for suspended ceiling installations and SL236FDI for fixed/structured ceiling installations.



Weight Capacity	Extension	Max Projector Size (HxWxD)	Ceiling Opening (HxWxD)	Ceiling Closure (WxD)
15.9 kg	914 mm	235 x 521 x 578 mm	282 x 648 x 724 mm	607 x 607 mm

SLBUW Interface is required. Remote control and IR eye are not included.

SL151I SMART-LIFT



Provides exceptionally smooth and quiet movement. Great for suspended and finished ceilings in homes and corporate offices.

Weight Capacity	Extension	Max Projector Size (HxWxD)	Ceiling Opening (HxWxD)	Ceiling Closure (WxD)
15.9 kg	211 mm	213 x 464 x 464 mm	284 x 597 x 597 mm	514 x 515 mm

SLBUW Interface is required. Remote control and IR eye are not included.



AUTOMATED PROJECTOR MOUNT ACCESSORY



IR10	Compatibility
Infrared Remote Control*	SL151, SL236 and SL220

**Included with SL220i*



WALL PROJECTOR MOUNTS

WM SERIES SHORT THROW MOUNTS FEATURES

 **PRECISION HEIGHT AND LEVELING**
Industry-first micro height and leveling adjustment.

 **FAST INSTALLATION**
Innovative quick-connect system for a speedy install.

 **INTEGRATED CABLE MANAGEMENT**
Fully internal cable management system conceals and protects cables for a clean finish.

 **VARIABLE EXTENSION OPTIONS**
Telescoping extension and infinite projector placement make it easy to achieve a picture perfect installation.

 **MULTIPLE INSTALLATION OPTIONS**
Designed for mounting to concrete, block wall, wood or steel studs. Hardware Included.

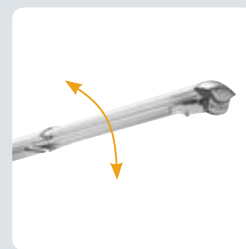

PRECISION HEIGHT
& LEVELING

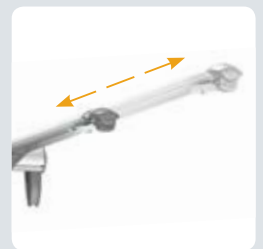

VARIABLE EXTENSION
OPTIONS

WM SERIES DUAL STUD SHORT THROW PROJECTOR MOUNTS



Dual stud short throw mounts. All models include Mini Elite™ Projector Mount.



WM SERIES SINGLE STUD SHORT THROW PROJECTOR MOUNTS



Single stud short throw mounts. All models include Mini Elite™ Projector Mount.



SPECIFICATIONS

Model	Extension	Leveling	Lateral Shift	Weight Capacity	Color
WM110AUS Single Wall Plate Mount	0 - 18" (0 - 457 mm)	±3°	-	25 lbs (11.3 kg)	S
WM120AUS Single Wall Plate Mount	18 - 30" (457 - 762 mm)	±3°	-	25 lbs (11.3 kg)	S
WM130AUS Single Wall Plate Mount	30 - 54" (762 - 1372 mm)	±3°	-	25 lbs (11.3 kg)	S
WM210AUS Dual Wall Plate Mount	0 - 18" (0 - 457 mm)	±3°	13" (330 mm)	25 lbs (11.3 kg)	S
WM220AUS Dual Wall Plate Mount	18 - 30" (457 - 762 mm)	±3°	13" (330 mm)	25 lbs (11.3 kg)	S
WM230AUS Dual Wall Plate Mount	30 - 54" (762 - 1372 mm)	±3°	13" (330 mm)	25 lbs (11.3 kg)	S

WP2 SERIES SHORT THROW MOUNT FEATURES



PRECISION ADJUSTMENT
Integrated micro pitch and lateral shift adjustment to speed up image registration.



VARIABLE EXTENSION OPTION
Projector mount slides along arm for infinite projector placement.



INTEGRATED CABLE MANAGEMENT
Aesthetic covers and internal cable management system conceal and protect cables for a clean finish.



MULTIPLE INSTALLATION OPTIONS
Designed for mounting to concrete, block wall, wood or steel studs Includes mounting hardware.

WP SERIES SHORT THROW PROJECTOR MOUNTS



Dual or single stud short throw mount. Includes Mini Projector Mount.



SPECIFICATIONS

Model	Extension	Leveling	Lateral Shift	Weight Capacity	Color
WP21US Dual Wall Plate Mount	2 - 24" (50 - 600 mm)	+4°/-0°	1.75" (44 mm)	25 lbs (11.3 kg)	S
WP22US Dual Wall Plate Mount	24 - 40" (610 - 1020 mm)	+4°/-0°	1.75" (44 mm)	25 lbs (11.3 kg)	S
WP23US Dual Wall Plate Mount	40 - 56" (1020 - 1420 mm)	+4°/-0°	1.75" (44 mm)	25 lbs (11.3 kg)	S



FIXED DISPLAY WALL MOUNTS

FUSION™ FIXED MOUNT FEATURES



CONTROLZONE™ LEVELING

Post-installation fine-tuning of height and leveling eliminates time needed for repositioning the mount and adjusts the entire configuration, not just the display.



CENTERLESS™ SHIFT

Generous post-installation lateral shift allows for perfect display positioning.



CLICKCONNECT™

Tool-less latching makes an audible click when a Fusion mount is safely engaged with the screen. Magnetic quick-store cords are easily hidden while remaining accessible.

XSM1U 55 - 90" MICRO-ADJUST MOUNT



For extra large displays with wide and/or tall mounting patterns.

Weight Capacity	Dimensions (HxWxD)	Mounting Patterns (W,H)	Max Lateral Shift	Height Adjust
113.4 kg	667 x 1086 x 57 mm	100 x 100 - 1070 x 600 mm	543 mm	25 mm

Note: add FCAV1U pull-out accessory to simplify recessed installations and increase access for display maintenance

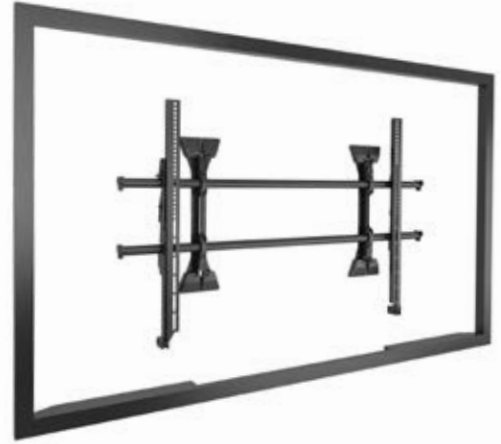

LSM1U 37 - 80" MICRO-ADJUST MOUNT



Our top performing fixed mount fits most displays on the market.

Weight Capacity	Dimensions (HxWxD)	Mounting Patterns (W,H)	Max Lateral Shift	Height Adjust
90.7 kg	464 x 883 x 51 mm	100 x 100 - 871 x 500 mm	441 mm	25 mm

Note: add FCAV1U pull-out accessory to simplify recessed installations and increase access for display maintenance

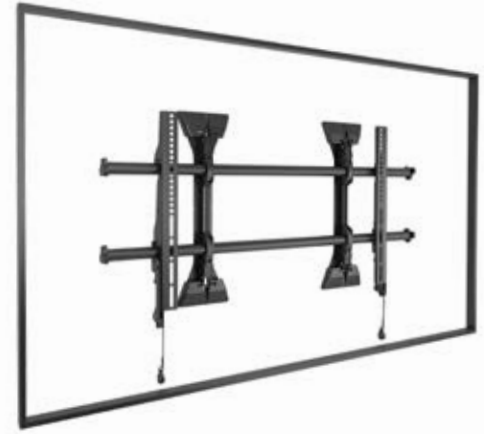

LSA1U 37 - 80" WALL MOUNT



This option without micro height adjustment is ideal for installs using Chief connector kits for multi-display installations.

Weight Capacity	Dimensions (HxWxD)	Mounting Patterns (W,H)	Max Lateral Shift	Height Adjust
90.7 kg	455 x 883 x 51 mm	100 x 100 - 870 x 500 mm	441 mm	N/A

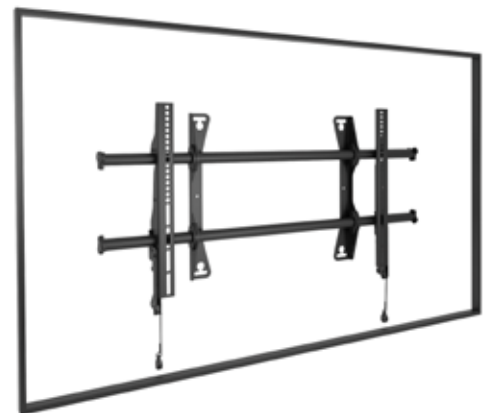

MSM1U 32 - 47" MICRO-ADJUST MOUNT



The smaller version of the LSM1U for shorter and/or narrower mounting patterns.

Weight Capacity	Dimensions (HxWxD)	Mounting Patterns (W,H)	Max Lateral Shift	Height Adjust
56.7 kg	464 x 654 x 51 mm	100x 100 - 642 x 400 mm	327 mm	25 mm

Note: add FCAV1U pull-out accessory to simplify recessed installations and increase access for display maintenance



MSA1U 32 - 47" WALL MOUNT







This option without micro height adjustment is ideal for installs using Chief connector kits for multi-display installations.

Weight Capacity	Dimensions (HxWxD)	Mounting Patterns (W,H)	Max Lateral Shift	Height Adjust
56.7 kg	455 x 654 x 51 mm	100 x 100 - 642 x 400 mm	327 mm	N/A



FUSION™ DYNAMIC HEIGHT ADJUST WALL MOUNTS

FEATURES

- 
DYNAMIC HEIGHT ADJUST
 Instantly raise and lower the display up to 400 mm by hand, no electricity needed.
- 
CONTROLZONE™ LEVELING
 Tool-less latching with a sliding flag for fast installation.
- 
CLICKCONNECT™
 A kickstand makes cable access convenient while the open wall plate allows for easy electrical placement behind the display.
- 
CUSTOMIZABLE
 A host of available accessories allows for customized solutions to meet any need.



HEIGHT ADJUST

LSDIU & MSDIU DYNAMIC WALL MOUNTS



Fast, easy height adjustment increases access to interactive displays. Includes integrated security flag.

Model	Weight Capacity Range	Dimensions (HxWxD)	Vertical Travel	Mounting Pattern Range
LSDIU	57 - 80 kg	635 x 884 x 130 mm	400 mm	200 x 200 - 800 x 400 mm
MSDIU	31 - 60 kg			



FUSION™ FIXED MOUNT ACCESSORIES



FCA830/ FCA840		Compatibility
Center Channel Speaker Adapter		Fusion Fixed & Tilt Wall, Free-standing & Ceiling Mounts
Model	Typical Screen Size	Weight Capacity
FCA830	52 - 80"	9.1 kg
FCA840	70 - 100"+	9.1 kg



FCA831/ FCA841		Compatibility
Center Channel Speaker Adapter		Fusion Fixed & Tilt Wall, Free-standing & Ceiling Mounts
Model	Typical Screen Size	Weight Capacity
FCA831	42 - 70"	4.5 kg/side
FCA841	50 - 95"	4.5 kg/side



FCA112	Equipment Depth Range	Compatibility
Secure CPU/Media Player Adapter	0 - 41 mm	Large & Extra Large Fusion Wall Mounts



FCAVIU	Extension	Weight Capacity	Compatibility
Fusion Pull Out Accessory	293 mm	68 kg	XTM1U, XSM1U, LTM1U, LTM1UP, LSM1U, MTM1U, MSM1U



FCA113	Compatibility
Extension Accessory for Behind-Mount Storage Space	All Fusion Wall Mounts



FCK000/008/016		Compatibility
Connector Kits		Fusion Fixed & Tilt Wall Mounts
Model	Width	
FCK000	Adds zero length to the poles	
FCK008	203 mm	
FCK016	406 mm	



FCA800/ FCA801		Compatibility
Above/Below Shelf, Large* Displays		Fusion Fixed & Tilt Wall, Free-standing & Ceiling Mounts
Model	Size	Weight Capacity
FCA800	203 mm	9.1 kg
FCA801	355 mm	9.1 kg

*Typical screen size: 46-70".



FCA810/ FCA811		Compatibility
Above/Below Shelf, XL* Displays		Fusion Fixed & Tilt Wall, Free-standing & Ceiling Mounts
Model	Size	Weight Capacity
FCA810	203 mm	9.1 kg
FCA811	355 mm	9.1 kg

* Typical screen size: 70-100".



FCA820/ FCA821		Compatibility
Fusion Center Camera Shelf		Fusion Ceiling, Freestanding and Wall Mounts
Model	Size	Weight Capacity
FCA820	203 mm	9.1 kg
FCA821	355 mm	9.1 kg



FCA802/FCA812		Compatibility
Component Shelf, Large and XL Displays		Fusion Fixed & Tilt Wall, Free-standing & Ceiling Mounts
Model	Typical Screen Size	Weight Capacity
FCA802	46 - 70"	9.1 kg
FCA812	70 - 100"	9.1 kg



FCA106	Compatibility
Side Cover Accessory	Fusion Fixed & Tilt Wall Mounts

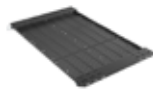

CSPH	Dimensions	Weight Capacity
Under Table Component Storage Panel	693 x 366 x 29 mm	9 kg



CSPR	Dimensions	Weight Capacity	Compatibility
On-Wall Component Storage Panel	615 x 264 x 29 mm	9 kg	Medium to Extra-Large Wall Mounts



FCAC06B	Dimensions	Weight Capacity
Wall Display Cover Accessory	15.4 cm depth x 213.4 cm length	All Chief Wall Mounts

THININSTALL™ FIXED MOUNT

FEATURES



ULTRA-LOW PROFILE

At less than the width of a penny, these mounts provide an ultra-thin profile to showcase any flat-screen display.



GLIDE LOCK™

Tool-less latching with a sliding flag for fast installation.



CABLE KICKSTAND

A kickstand makes cable access convenient while the open wall plate allows for easy electrical placement behind the display.

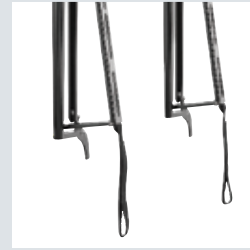

CABLE KICKSTAND



GLIDE LOCK™

LSTU 37 - 63" ULTRA-LOW PROFILE



Thinner than the diameter of a penny, this versatile mount is great for ultra-slim flat panels.

Weight Capacity	Dimensions (HxWxD)	Mounting Patterns (W,H)
56.7 kg	628 x 907 x 10 mm	200 x 200 - 800 x 500 mm



MSTU 26 - 47" ULTRA-LOW PROFILE



Accommodates different mounting patterns than the LSTU and allows for landscape and portrait orientations.

Weight Capacity	Dimensions (HxWxD)	Mounting Patterns (W,H)
56.7 kg	530 x 706 x 10 mm	100 x 100 - 600 x 400 mm



OTHER FIXED WALL MOUNTS

PSMH CUSTOM & HEAVY DUTY MOUNTS

XL

A heavy-duty series of mounts for extra large flat panels with custom solutions available.

Model	Weight Capacity	Dimensions (HxWxD)	Mounting Patterns (W,H)	Compatibility
PSMH2079*	158.7 kg	660 x 1380 x 67 mm	1200, 1100, 1000, 900, 800, 700, 600, 500, 400 x 600 or 400 mm	80"+ Interactive Displays
PSMH2860	34 kg	287 x 688 x 33 mm	600 x 200 mm	Stretch Displays

Visit milestone.com for additional PSMH model specifications.

*The PSMH2079 is designed to support the 84" Microsoft® Surface Hub™ and similar XL interactive solutions.



FSR1U 10 - 32" WALL MOUNT

S

Quick-connect wall mount for small displays. The ultra low profile allows for portrait or landscape options with Q-Latch™ mounting system.

Weight Capacity	Dimensions (HxWxD)	Mounting Patterns (W,H)
20.4 kg	178 x 152 x 18 mm	50 x 50, 75 x 75, 100 x 100, 200 x 100 x 200 x 200 mm

*Additional mounting patterns may be achieved by adding FHB series accessory adapter. Check MountFinder for further details and to verify compatibility.

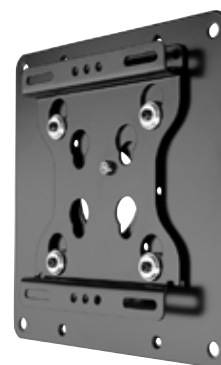

OTHER FIXED WALL MOUNT ACCESSORIES



PAC101	Compatibility
Component Wall Shelf	All Chief Wall Mounts







PAC103	Compatibility
Accessory Shelf Safety Strap	PAC101



TILT DISPLAY WALL MOUNTS

FUSION™ TILT MOUNT FEATURES

- 
CONTROLZONE™ LEVELING
 Post-installation fine-tuning of height and leveling eliminates time needed for repositioning the mount and adjusts the entire configuration, not just the display.
- 
CENTERLESS™ SHIFT
 Generous post-installation lateral shift allows for perfect display positioning.
- 
CENTRIS™ LOW-PROFILE TILT
 Uses the center of gravity to balance the screen while maintaining a low profile. The display stays in place until readjusted.
- 
CLICKCONNECT™
 Tool-less latching makes an audible click when a Fusion mount is safely engaged with the screen.



CONTROLZONE
LEVELING

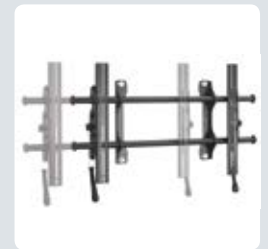

CENTERLESS SHIFT

XTM1U 55 - 90" MICRO-ADJUST MOUNT



Works best with extra large displays with wide and/or tall mounting patterns.

Weight Capacity	Dimensions (HxWxD)	Mounting Patterns (W,H)	Max Lateral Shift	Height Adjust	Tilt
113.4 kg	622 x 1086 x 64 mm	100 x 100 - 1070 x 600 mm	542 mm	25 mm	+5°, -12°

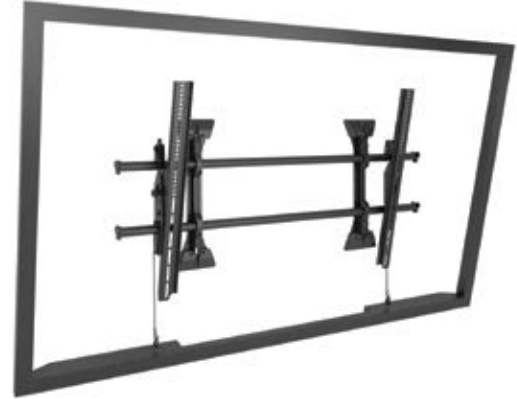

LTM1U 37 - 80" MICRO-ADJUST MOUNT



Our top performing tilt mount fits most displays on the market.

Weight Capacity	Dimensions (HxWxD)	Mounting Patterns (W,H)	Max Lateral Shift	Height Adjust	Tilt
90.7 kg	432 x 883 x 51 mm	100 x 100 - 878 x 500 mm	441 mm	25 mm	+2°, -12°

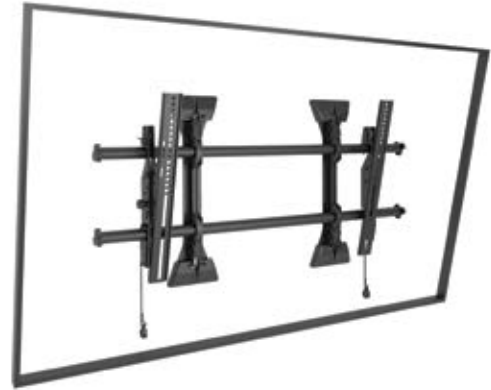

LTA1U 37 - 80" WALL MOUNT



This option without micro height adjustment is ideal for installs using Chief connector kits for multi-display installations.

Weight Capacity	Dimensions (HxWxD)	Mounting Patterns (W,H)	Max Lateral Shift	Height Adjust	Tilt
90.7 kg	419 x 883 x 51 mm	100 x 100 - 875 x 500 mm	441 mm	N/A	+2°, -12°

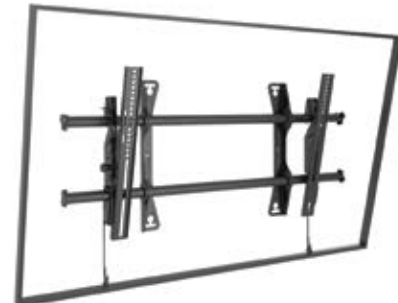

MTM1U 32 - 55" MICRO-ADJUST MOUNT

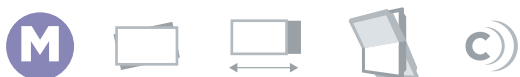

Works best with mid-size displays, providing a flexible, dual-stud installation for maximum lateral shift

Weight Capacity	Dimensions (HxWxD)	Mounting Patterns (W,H)	Max Lateral Shift	Height Adjust	Tilt
56.7 kg	432 x 654 x 51 mm	100 x 100 - 650 x 400 mm	327 mm	25 mm	+2°, -12°



MTMP1U 45 - 55" PORTRAIT/MICRO-ADJUST



The portrait version of the popular MTM1U.

Weight Capacity	Dimensions (HxWxD)	Mounting Patterns (W,H)	Max Lateral Shift	Height Adjust	Tilt
56.7 kg	622 x 530 x 81 mm	100 x 100 - 600 x 570 mm	265 mm	25 mm	+5°, -12°



MTA1U 32 - 55" WALL MOUNT



This option without micro height adjustment is ideal for installs using Chief connector kits for multi-display needs.

Weight Capacity	Dimensions (HxWxD)	Mounting Patterns (W,H)	Max Lateral Shift	Height Adjust	Tilt
56.7 kg	419 x 654 x 51 mm	100 x 100 - 650 x 400 mm	327 mm	N/A	+2°, -12°



MTMS1U 32 - 47" PORTRAIT/LANDSCAPE MICRO-ADJUST



Single-stud design hides better behind smaller, narrow-bezel displays and supports both portrait and landscape orientations.

Weight Capacity	Dimensions (HxWxD)	Mounting Patterns (W,H)	Max Lateral Shift	Height Adjust	Tilt
34 kg	359 x 463 x 51 mm	200 x 200 - 400 x 450 mm	N/A	25 mm	+2°, -12°



STMS1U 24 - 32" PORTRAIT/LANDSCAPE MICRO-ADJUST



Single-stud design hides better behind smaller, narrow-bezel displays and supports both portrait and landscape orientations.

Weight Capacity	Dimensions (HxWxD)	Mounting Patterns (W,H)	Max Lateral Shift	Height Adjust	Tilt
34 kg	359 x 362 x 51 mm	75 x 75 - 300 x 300 mm	N/A	25 mm	+2°, -12°



FUSION™ TILT MOUNT ACCESSORIES

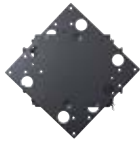

FRA	Compatibility
Freestyle Rotation Adapter	200 x 200, 200 x 300, 200 x 400, 300 x 300, 400 x 400 mm
<ul style="list-style-type: none"> Provides 90° of rotation for infinite orientation possibilities Enables a wide variety of video wall configurations, as well as easy portrait-to-landscape rotation Compatible with a range of ConnexSys and Fusion Series mounts. Compatible screen size and weight capacity vary by mount, visit milestone.com for details. 	



FCADA	Weight Capacity	Compatibility
Fusion Depth Accessory	56.7 kg	For use with FRA & STMSIU or MTMSIU



FCA830/ FCA840	Compatibility	
Center Channel Speaker Adapter	Fusion Fixed & Tilt Wall, Freestanding & Ceiling Mounts	
Model	Typical Screen Size	Weight Capacity
FCA830	52 - 80"	9.1 kg
FCA840	70 - 100"+	9.1 kg



FCA831/ FCA841	Compatibility	
Center Channel Speaker Adapter	Fusion Fixed & Tilt Wall, Freestanding & Ceiling Mounts	
Model	Typical Screen Size	Weight Capacity
FCA831	42 - 70"	4.5 kg/side
FCA841	50 - 95"	4.5 kg/side



FCA112	Equipment Depth Range	Compatibility
Secure CPU/Media Player Adapter	0 - 41 mm	Large & Extra Large Fusion Wall Mounts



FCA113	Compatibility
Extension Accessory for Behind-Mount Storage Space	All Fusion Wall Mounts



FCAV1U	Weight Capacity	Compatibility
Pull-Out Accessory	68 kg	Fusion Micro-Adjustable Fixed and Tilt Mounts



FCK000/008/016	Compatibility
Connector Kits	Fusion Fixed & Tilt Wall Mounts
Model	Width
FCK000	Adds zero length to the poles
FCK008	203 mm
FCK016	406 mm



FCA800/ FCA801	Compatibility	
Above/Below Shelf, Large* Displays	Fusion Fixed & Tilt Wall, Freestanding & Ceiling Mounts	
Model	Size	Weight Capacity
FCA800	203 mm	9.1 kg
FCA801	355 mm	9.1 kg

*Typical screen size: 46-70".



FCA810/ FCA811	Compatibility	
Above/Below Shelf, XL* Displays	Fusion Fixed & Tilt Wall, Freestanding & Ceiling Mounts	
Model	Size	Weight Capacity
FCA810	203 mm	9.1 kg
FCA811	355 mm	9.1 kg

* Typical screen size: 70-100".



FCA820/ FCA821	Compatibility	
Fusion Center Camera Shelf	Fusion Ceiling, Freestanding and Wall Mounts	
Model	Size	Weight Capacity
FCA820	203 mm	9.1 kg
FCA821	355 mm	9.1 kg

FUSION™ TILT MOUNT ACCESSORIES







FCA802/FCA812		Compatibility
Component Shelf, Large Displays		Fusion Fixed & Tilt Wall, Free-standing & Ceiling Mounts
Model	Typical Screen Size	Weight Capacity
FCA802	46 - 70"	9.1 kg
FCA812	70 - 100"	9.1 kg



FCA106	Compatibility
Side Cover Accessory	Fusion Fixed & Tilt Wall Mounts

THINSTALL™ TILT MOUNT FEATURES

- 
ULTRA-LOW PROFILE
 At less than the width of a penny, these mounts provide an ultra-thin profile to showcase any flat-screen display.
- 
GLIDE LOCK
 Tool-less latching with a sliding flag for fast installation.
- 
CENTRIS LOW-PROFILE TILT
 Uses the center of gravity to balance the screen while maintaining a low profile. The display stays set in place until readjusted.
- 
CABLE KICKSTAND
 A kickstand makes cable access hands-free while the open wall plate allows for easy electrical placement behind the display.



GLIDE LOCK™ LATCH



CABLE MANAGEMENT

LTTU 37 - 80" ULTRA-LOW PROFILE



At 19 mm thick, this mount combines an ultra-thin profile with the functionality of 12 degrees of tilt.

Weight Capacity	Dimensions (HxWxD)	Mounting Patterns (W,H)	Max Screen Thickness	Tilt
45.4 kg	548 x 907 x 19 mm	200 x 200 - 800 x 500 mm	51 mm	-12°



MTTU 26 - 55" ULTRA-LOW PROFILE



Like the LTTU but it allows for different mounting patterns and both landscape and portrait screen orientations.

Weight Capacity	Dimensions (HxWxD)	Mounting Patterns (W,H)	Max Screen Thickness	Tilt
45.4 kg	448 x 706 x 19 mm	100 x 100 - 600 x 400 mm	51 mm	-12°



OTHER TILT WALL MOUNTS

ODMLT 32 - 80" OUTDOOR TILT MOUNT



Designed to support all-weather outdoor installations with a weatherproof protective outdoor-rated finish and stainless-steel hardware.

Weight Capacity	Dimensions (HxWxD)	Mounting Patterns (W,H)	Max Lateral Shift	Tilt
79.3 kg	457 x 737 x 83 mm	127 x 100 - 643 x 430 mm	51 mm	±15°



MWCU 26 - 55" MOUNT WITH CPU STORAGE



Provides an all-in-one tilt wall mount solution for both a medium-sized flat panel display and CPU or receiver.

Weight Capacity	Dimensions (HxWxD)	Mounting Patterns (W,H)	Max Equip Size (HxWxD)	Tilt
45.4 kg	303 x 487 x 114 mm	100 x 100 - 709 x 431 mm	356 x 478 x 97 mm	-15°



FTRIU 10 - 32" WALL MOUNT



A small option for flat panel displays or monitors that allows for portrait or landscape options with Q-Latch™ mounting system.

Weight Capacity	Dimensions (HxWxD)	Mounting Patterns (W,H)	Tilt
20.4 kg	162 x 147 x 48 mm	50 x 500 - 200 x 200 mm*	+5°, -15°

*Additional mounting patterns may be achieved by adding FHB series accessory adapters. Check MountFinder for further details and to verify compatibility.





MENU BOARD DISPLAY WALL MOUNTS

FUSION™ MENU BOARD MOUNT FEATURES

- 

CONTROLZONE LEVELING
Post-installation fine-tuning of height and leveling up to ±25 mm — 4x1 and 5x1 configurations include a floating center wall bracket.
- 

LATERAL SHIFT
Wall brackets can be shifted around outlets and keep displays centered regardless of stud positioning.
- 

INDEPENDENT DEPTH ADJUST
Independent depth adjust of 25 mm, from 147-173 mm, accommodates media players and cabling behind the displays and compensates for uneven walls.
- 

CENTRIS TILT
Uses the center of gravity to balance the screen with a tilt range from 0-20 degrees and locking points at 0, 10 and 20 degrees.
- 

60" OPTION **ADD EXTENSION**
FCAX accessories increase rail length for larger displays, up to 60".

LWM5X1U LANDSCAPE MENU BOARD



The largest of our wall-mounted menu boards, this configuration is five screens across with a floating third wall bracket. Fits 40 – 55" displays.

Weight Capacity (per screen)	Dimensions (HxWxD)	Mounting Patterns (W,H)	Depth Adjust	Tilt
56.7 kg	43 x 490 x 15 cm	any width x 100-400 mm	147-173 mm	20°



LWM4X1U LANDSCAPE MENU BOARD



A classic four-screen configuration with a floating third wall bracket. Fits 40 – 55" displays.

Weight Capacity (per screen)	Dimensions (HxWxD)	Mounting Patterns (W,H)	Depth Adjust	Tilt
56.7 kg	43 x 399 x 15 cm	any width x 100-400 mm	147-173 mm	20°



LWM3X1U LANDSCAPE MENU BOARD



This standard 3-screen configuration securely supports displays with just two mounting brackets. Fits 40 – 55" displays.

Weight Capacity (per screen)	Dimensions (HxWxD)	Mounting Patterns (W,H)	Depth Adjust	Tilt
56.7 kg	43 x 276 x 15 cm	any width x 100-400 mm	147-173 mm	20°



LWM3X1UP PORTRAIT MENU BOARD



The portrait version of the LWM3x1U. Fits 40 – 55" displays.

Weight Capacity (per screen)	Dimensions (HxWxD)	Mounting Patterns (W,H)	Depth Adjust	Tilt
56.7 kg	43 x 175 x 15 cm	any width x 100-400 mm	147-173 mm	20°

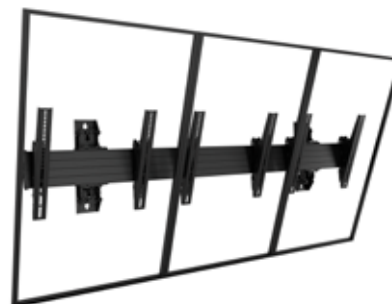

LWM2X1U LANDSCAPE MENU BOARD



A smaller two-screen configuration for tighter spaces.
Fits 40 - 55" displays.

Weight Capacity (per screen)	Dimensions (HxWxD)	Mounting Patterns (W,H)	Depth Adjust	Tilt
56.7 kg	43 x 183 x 15 cm	any width x 100-400 mm	147-173 mm	20°



LWM2X1UP PORTRAIT MENU BOARD



The portrait version of the LWM2x1U. Fits 40 - 55" displays.

Weight Capacity (per screen)	Dimensions (HxWxD)	Mounting Patterns (W,H)	Depth Adjust	Tilt
56.7 kg	43 x 119 x 15 cm	any width x 100-400 mm	147-173 mm	20°



FUSION™ MENU BOARD DISPLAY WALL MOUNT ACCESSORIES



FCAX08/14/20		Compatibility
Video Wall Extension Brackets		Fusion Video Wall & Menu Board Ceiling and Wall Mounts
Model	Length	
FCAX08	203 mm	
FCAX14	356 mm	
FCAX20	508 mm	



FCA112	Equipment Depth Range	Compatibility
Secure CPU/Media Player Adapter	0 - 41 mm	Large & Extra Large Fusion Wall Mounts

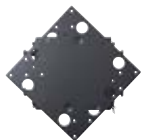

FRA	Compatibility
Freestyle Rotation Adapter	200 x 200, 200 x 300, 200 x 400, 300 x 300, 400 x 400 mm
<ul style="list-style-type: none"> Provides 90° of rotation for infinite orientation possibilities Enables a wide variety of video wall configurations, as well as easy portrait-to-landscape rotation Compatible with a range of ConnexSys and Fusion Series mounts. Compatible screen size and weight capacity vary by mount, visit milestone.com for details. 	



FCA510/515		Compatibility
Storage Accessories		All Fusion Ceiling & Freestanding Mounts
Model	Dimensions (HxWxD)	
FCA510	267 x 267 x 76 mm	
FCA515	394 x 394 x 114 mm	



FCA520	Max. Equipment Depth	Compatibility
Universal Clamp Kit (Qty 2)	83 mm	All Fusion Ceiling & Freestanding Mounts

DON'T SEE THE CONFIGURATION YOU NEED IN THIS CATALOG? NO PROBLEM.

Chief's Fusion Modular Series allows you to build what you need. Paired with our powerful Multi-Display Configurator, the Modular Series allows you to specify exact installation requirements and provides the list of components needed to safely build your most creative applications – all with standard lead times.

HOW DOES IT WORK?

1. Go to milestone.com/FusionConfigurator
2. Answer a few questions about your project (number of rows & columns, display information, etc.)
3. We'll calculate the capacity and provide a required parts list

ORDER EXAMPLE



FUSION MODULAR COMPONENTS



Display Interface Sets	
Model	Description
FCASFP	Small/Medium Tilt Interface
FMSITL	Large Tilt Interface
FMSIML	Large Micro-Adjust Tilt Interface



Caps and Connectors	
Model	Description
FMSHC1	Horizontal Row Connector
FMSHCO	Ceiling Array Offset
FMSECAP	Horizontal Row End Cap



Extrusion Options	
Model	Description
FMSH48	122 cm Horizontal Row
FMSH60	152 cm Horizontal Row
FMSH72	183 cm Horizontal Row
FMSH84	213 cm Horizontal Row
FMSH96	244 cm Horizontal Row
FMSH108	274 cm Horizontal Row
FMSH120	305 cm Horizontal Row



Column Attachments	
Model	Description
FMSCM	Height-Adjustable Column Attachment
FMSCA	Floating Column Attachment







Wall Attachments	
Model	Description
FMSWM	Height-Adjustable Wall Attachment
FMSWA	Floating Wall Attachment



VIDEO WALL DISPLAY WALL MOUNTS

VIDEO WALL
DISPLAY WALL
MOUNTS

CONNEXSYS™ VIDEO WALL SYSTEM FEATURES

-  **SPEED LEVELING**
Mount multiple units to a single strut channel for quick row leveling and centerless lateral shift.
-  **POWERZONE™ ADJUSTMENTS**
Six points of tool-free adjustment: height, depth, lateral and tilt are all found in one easy-to-access location. Rigid frame keeps displays where you set them even after extending for service.
-  **RAPIDDRAW™ DISPLAY RELEASE**
Cord release system gently and remotely pops any screen out 349 mm from the wall for easy access and service while minimizing aggressive screen pushes. Get an additional 20 degrees of bottom pull-out with an integrated kickstand. Cords can be set to release from any 90 degree angle.
-  **GENEROUS DEPTH ADJUSTMENT**
Mount depth from wall can be set between 102 and 186 mm for perfect alignment, accommodating for recess applications and wall imperfections.

LVS1U 42 - 80" LANDSCAPE SYSTEM WITH RAILS



This universal pop-out mount is ideal for large-scale, seamless video walls and recessed applications. Ships with rails for each mount.

Weight Capacity	Dimensions (HxWxD)	Mounting Patterns (WxH)	Tilt	Height Adjust	Total Depth Adjust
68 kg	531 x 903 x 101 mm	200 x 100 - 700 x 400 mm*	+4° / -2.5°	± 25 mm	85 mm

* Add FHB5050 interface adapter for compatibility with 800 x 400 mm mounting patterns.

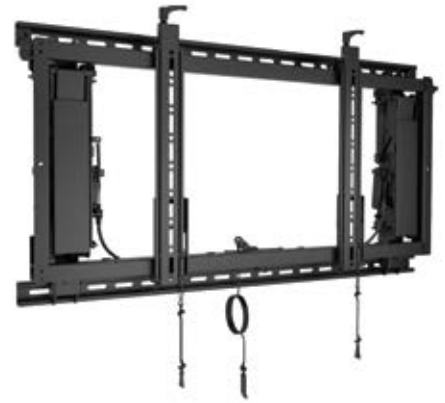

LVS1UP 40 - 80" PORTRAIT SYSTEM WITH RAILS



The portrait version of the LVS1U that ships with rails for each mount.

Weight Capacity	Dimensions (HxWxD)	Mounting Patterns (WxH)	Tilt	Height Adjust	Total Depth Adjust
68 kg	826 x 496 x 104 mm	200 x 100 - 800 x 400 mm	+4° / -2.5°	± 25 mm	85 mm



LVSXU 42 - 80" LANDSCAPE SYSTEM WITHOUT RAILS



Nearly identical to the LVS1U but ships without rails so installers can source strut locally to hang multiple mounts to one rail and reduce installation time.

Weight Capacity	Dimensions (HxWxD)	Mounting Patterns (WxH)	Tilt	Height Adjust	Total Depth Adjust
68 kg	554 x 903 x 102 mm	200 x 100 - 700 x 400 mm*	+4° / -2.5°	± 25 mm	85 mm

* Add FHB5050 interface adapter for compatibility with 800 x 400 mm mounting patterns.



LVSXUP 40 - 80" PORTRAIT SYSTEM WITHOUT RAILS

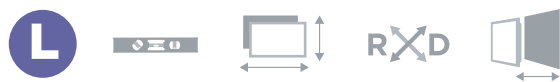

The portrait version of the LVSXU that also ships without rails.

Weight Capacity	Dimensions (HxWxD)	Mounting Patterns (WxH)	Tilt	Height Adjust	Total Depth Adjust
68 kg	826 x 496 x 104 mm	200 x 100 - 800 x 400 mm	+4° / -2.5°	± 25 mm	85 mm



CONNEXSYS VIDEO WALL SYSTEM ACCESSORIES



FHB5050	Dimensions*	Compatibility
800 x 400 mm Interface Adapter	432 x 120 x 16 mm	LVS1U, LV SXU

*Dimensions given are for one side of the two-piece FHB5050 bracket.



CSA100	Dimensions	Compatibility
Device Holder	250 x 202 x 38 mm	All ConnexSys Mounts



CSACLIPS	Dimensions	Compatibility
Cable Quick Ties (Qty 100)	35 x 19 x 23 mm	All ConnexSys Mounts



CSACK06B	Dimensions	Compatibility
Side Cover Kit	15.4 x 15.4 x 213.4 cm	All ConnexSys Mounts

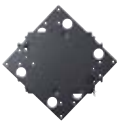

FRA	Dimensions	Compatibility
Freestyle Rotation Adapter	438 x 438 x 21 mm	Max 400 x 400 mm Displays
<ul style="list-style-type: none"> Provides 90 degrees of rotation for infinite orientation possibilities. Enables a wide variety of video wall configurations, as well as easy portrait to landscape rotation. Compatible with a range of ConnexSys and Fusion Series mounts. Compatible screen size and weight capacity vary by mount, visit milestone.com for details. 		



FREESTYLE ROTATION ADAPTER SELECTION GUIDE

The FRA Freestyle Rotation Adapter enables an extremely wide variety of video wall configurations using either ConnexSys™ or Fusion® mounts. This versatile accessory provides infinite orientation possibilities, and the ability to overlap displays when combined with the FCADA Fusion depth accessory.

Use the information in this selection guide to determine the best solution to support your unique configuration.

CONFIGURATION STYLE

For configurations requiring precision multi-display alignment, we recommend The **ConnexSys Series**. Examples:

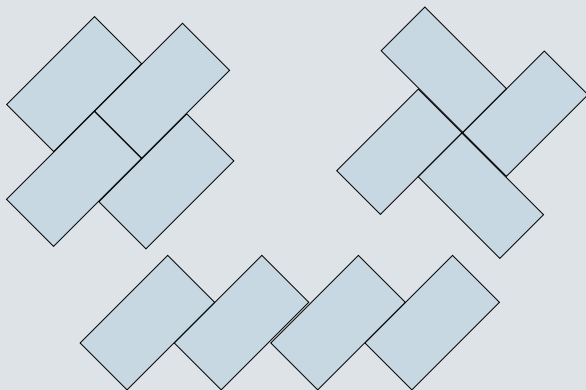

For configurations with overlapping displays, we recommend **Fusion Series single-stud mounts**. Examples:

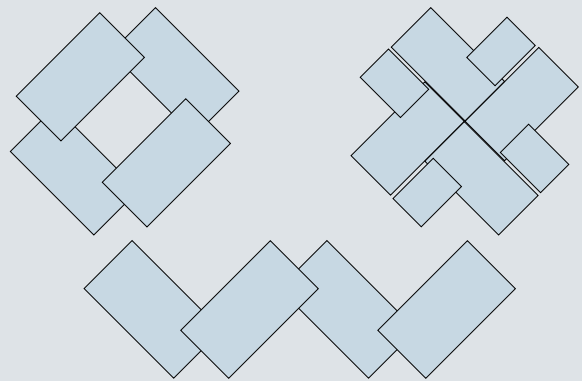

DISPLAY COMPATIBILITY

MODEL	DESCRIPTION	TYPICAL DISPLAY SIZE	MIN DISPLAY HEIGHT AT 45°	WEIGHT CAPACITY	MOUNTING PATTERN*
LVS1UP	ConnexSys Portrait Mount	55" +	686 mm	56.7 kg	200 x 200; 200 x 300; 200 x 400; 300 x 300; 400 x 400
LVS1U	ConnexSys Landscape Mount	42 - 80"	978 mm	56.7 kg	
STMS1U	Fusion Single-Stud Mount	40" +	483 mm	24.9 kg	
MTMS1U	Fusion Single-Stud Mount	40" +	483 mm	24.9 kg	
MSM1U	Fusion Dual-Stud Mount	58" +	737 mm	47.6 kg	
MODEL	DESCRIPTION	TYPICAL DISPLAY SIZE	MIN DISPLAY HEIGHT IN PORTRAIT	WEIGHT CAPACITY	MOUNTING PATTERN*
MFAUB	Fusion Stand	50" +	610 mm	47.6 kg	200 x 200; 200 x 300; 200 x 400; 300 x 300; 400 x 400
MPAUB	Fusion Cart	50" +	610 mm	47.6 kg	

*Mounting pattern options are determined by the Freestyle Adapter (FRA).

MINIMUM DISPLAY HEIGHT

The minimum display height noted in the chart above is the smallest display size that will cover the widest dimension of the mount being used. The minimum display height will increase if the display is rotated to lesser/greater angles. For assistance calculating the minimum display height at a different angle of rotation, please contact our customer care team.

ConnexSys and Fusion Series mounts can be combined to accomplish an extensive range of freestyle configurations. For anything not listed here - including ceiling and cart/stand applications - please contact our Customer Care team.

P: +31.495.580.840 **E:** emea.sales@milestone.com

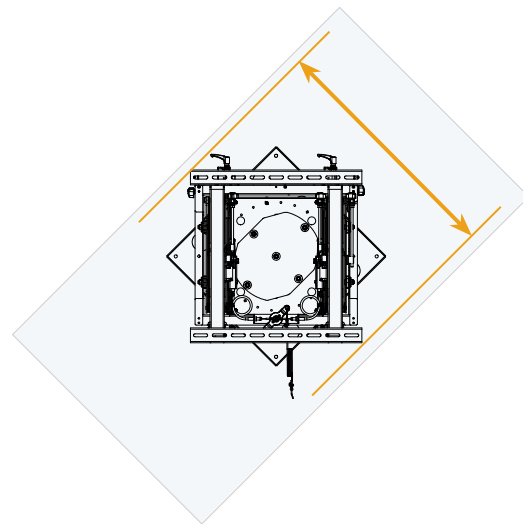



SWING ARM DISPLAY WALL MOUNTS

THINSTALL™ SWING ARM FEATURES



ULTRA-LOW PROFILE

These sleek designs retract down to 38 to 46 mm to provide an ultra-thin profile to showcase any flat-screen display.



CENTERLESS™ SHIFT

Generous post-installation lateral shift up to 406 mm allows for perfect display positioning.



CABLE MANAGEMENT

Enclosed, tool-less cable covers and a wide open wall plate make it easy to route power and signal cables.



CENTRIS™ FINGERTIP TILT

Uses the center of gravity to balance the screen for up to 15 degrees of easy tilt capability.



HEIGHT ADJUST

Adjust the height of the entire configuration post installation up to 25 mm.

TS525TU 37 - 58" EXTENDS 635 mm



This feature-rich swing arm fits most screens and has a large array of supporting accessories.

Weight Capacity	Dimensions (HxWxD)	Mounting Patterns (W,H)	Extension	Max Lateral Shift	Tilt	Height Adjust
56.7 kg	527 x 749 x 38 mm	100 x 100 - 800 x 400 mm	635 mm	406 mm	-15°	25 mm



TS325TU 26 - 52" EXTENDS 635 mm



Very similar to the TS525TU but with shorter wall plate and modified interface making it better suited for lighter displays.

Weight Capacity	Dimensions (HxWxD)	Mounting Patterns (W,H)	Extension	Max Lateral Shift	Tilt	Height Adjust
34 kg	439 x 749 x 46 mm	100 x 100 - 600 x 400 mm	635 mm	406 mm	-15°	25 mm



TS318TU 26 - 52" EXTENDS 457 mm



This mount has the same features as the TS325TU with 457 mm extension.

Weight Capacity	Dimensions (HxWxD)	Mounting Patterns (W,H)	Extension	Max Lateral Shift	Tilt	Height Adjust
34 kg	439 x 574 x 46 mm	100 x 100 - 600 x 400 mm	457 mm	406 mm	-15°	25 mm



TS318SU 26 - 52" EXTENDS 457 mm



This single stud version of the TS318 dual arm swing arm mount works well when lateral shift is not a necessity.

Weight Capacity	Dimensions (HxWxD)	Mounting Patterns (W,H)	Extension	Max Lateral Shift	Tilt	Height Adjust
34 kg	343 x 574 x 46 mm	100 x 100 - 600 x 400 mm	457 mm	N/A	-15°	25 mm



TS218SU 26 - 47" EXTENDS 457 mm



This single stud swing arm works well in corners and with most medium flat panels. It also accommodates portrait and landscape orientations.

Weight Capacity	Dimensions (HxWxD)	Mounting Patterns (W,H)	Extension	Max Lateral Shift	Tilt	Height Adjust
34 kg	356 x 330 x 38 mm	100 x 100 - 400 x 400 mm	457 mm	N/A	-12°	25 mm



TS118SU 10 - 32" EXTENDS 457 mm



Fits smaller patterns and screens than the TS218SU.

Weight Capacity	Dimensions (HxWxD)	Mounting Patterns (W,H)	Extension	Max Lateral Shift	Tilt	Height Adjust
15.9 kg	294 x 330 x 38 mm	75 x 75 - 200 x 200 mm	457 mm	N/A	-12°	N/A



TS110SU 10 - 32" EXTENDS 250 mm



This basic swing arm wall mount provides single arm extension and swivel for smaller displays.

Weight Capacity	Dimensions (HxWxD)	Mounting Patterns (W,H)	Extension	Max Lateral Shift	Tilt	Height Adjust
15.9 kg	239 x 356 x 38 mm	75 x 75 - 200 x 200 mm	250 mm	N/A	-12°	N/A



THININSTALL™ SWING ARM ACCESSORIES



TA100	Dimensions (WxD)	Weight Capacity	Compatibility
Component Shelf	457 x 305 mm	4.5 kg	TS525TU, TS325TU, TS318TU, TS318SU



TA200/250		Compatibility
Video Conference Camera Shelves - Above		TS525TU, TS325TU, TS318TU, TS318SU
Model	Dimensions (WxD)	Weight Capacity
TA200	203 x 184 mm	4.5 kg
TA250	305 x 184 mm	4.5 kg



TA300	Weight Capacity	Compatibility
Left/Right Speaker Adapter	4.5 kg	TS525TU, TS325TU, TS318TU, TS318SU



TA350	Weight Capacity	Compatibility
Center Channel Speaker Adapter	4.5 kg	TS525TU, TS325TU, TS318TU, TS318SU



TA410	Compatibility
Portrait Adapter	TS525TU, TS325TU, TS318TU, TS318SU



PACUNV1	Dimensions (HxWxD)	Weight Capacity	Compatibility
Component Adapter Bracket	146 x 174 x 38 mm	4.5 kg	PAC525 & PAC526 In-wall Boxes

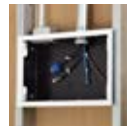

PAC525	Dimensions (HxWxD)	Compatibility
Small Multi-Depth Wall Box	229 x 362 x 99 mm	All Chief Wall Mounts
Model	Includes Flange	
PAC525	No	
PAC525FW	Yes	



PAC526	Dimensions (HxWxD)	Compatibility
Large Multi-Depth Wall Box	362 x 362 x 99 mm	All Chief Wall Mounts
Model	Includes Flange	
PAC526	No	
PAC526FW	Yes	



PAC527	Dimensions (HxWxD)	Compatibility
XL Multi-Depth Wall Box	362 x 559 x 99 mm	All Chief Wall Mounts
Model	Includes Flange	
PAC527	No	
PAC527FW	Yes	

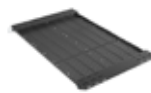

CSPH	Dimensions	Weight Capacity
Under Table Component Storage Panel	693 x 366 x 29 mm	9 kg



CSPR	Dimensions	Weight Capacity	Compatibility
On-Wall Component Storage Panel	615 x 264 x 29 mm	9 kg	Medium to Extra-Large Wall Mounts



OPTIMIZING EQUIPMENT STORAGE

THREE NEW SOLUTIONS



Under-Table

The CSPH provides storage near the action while eliminating the mess of cables and components under conference room tables and desks. The hinged design allows users to swing the panel 90° for easier access to components.

- Active mounting area of 355 x 622 mm
- 1/3 and 2/3 breakaways in case less space is required; Brackets available separately to use extra breakaway space elsewhere
- Handle for ease of transport, install and maneuvering of panel
- Security locking screws
- Shipped with template to ensure accurate mounting of brackets

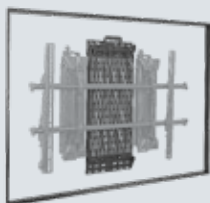

On-Wall

The CSPR has over 1032 square centimeters of secure attachment area for AV equipment independent of display mounts. Optimize large roll-outs by preloading components then sliding the panel into place.

- Active mounting area of 457 x 235 mm
- Installs behind or along any wall mount or display
- Removable for component service without moving the display
- Security locking mechanism
- Handle helps ease of transport, installation and removal of plate



In-Wall

The PAC527 provides a large, organizable space for installers to accommodate difficult equipment port locations, power cords and more. The backplane breaks into four sections that can be mounted on three different levels to organize, layer and attach AV equipment.

- Enclosure UL 2416 Listed for installation of AV, IT & Communication Technology Equipment
- Break away edges change the depth of the box from 89 to 64 mm
- Included universal backplane can be mounted at 3 different depths in 4 different locations; ships in two sections and can be broken down into a total of 4 smaller sections
- Provides a larger, easy-to-organize space to accommodate AV equipment - 559 mm tall
- Pre- and post-construction installation options
- Stud mountable
- Paintable, black or white flange and cover options to blend in any environment

OTHER SWING ARM MOUNTS

PDRUB 42 - 80" EXTENDS UP TO 940 mm



The heavy-duty swing arm option works for displays up to 90.7 kg and extends up to 940 mm. Supports both portrait and landscape orientations.

Weight Capacity	Dimensions (HxWxD)	Mounting Patterns (W,H)	Extension	Max Lateral Shift	Tilt	Color
90.7 kg	56 x 100.3 x 8.6 cm	200 x 200 - 862 x 517 mm	940 mm	229 mm	+5°, -16°	B



PNRUB 42 - 80" EXTENDS UP TO 635 mm



The smaller version of the PDR extends to 635 mm. Supports both portrait and landscape orientations.

Weight Capacity	Dimensions (HxWxD)	Mounting Patterns (W,H)	Extension	Max Lateral Shift	Tilt	Color
90.7 kg	538 x 687 x 84 mm	200 x 200 - 862 x 517 mm	635 mm	229 mm	+5°, -17°	B



ODMLA25 32 - 80" OUTDOOR SWING ARM MOUNT



The weather proof design with outdoor-rated finishings is UL Listed to UL 2442 Part 2 for Outdoor Use. Supports landscape orientations.

Weight Capacity	Dimensions (HxWxD)	Mounting Patterns (W,H)	Extension	Tilt	Color
68 kg	470 x 748 x 124 mm	75 x 75 mm - 709 x 444 mm	550 mm	+/-15°	B



OTHER SWING ARM MOUNT ACCESSORIES



PAC715/PAC716		Compatibility
Video Conference Camera Shelves - Above or Below		PDR, PNR & Other Q-Latch Mounts
Model	Dimensions (WxD)	Weight Capacity
PAC715	229 x 223 mm	4.5 kg
PAC716	356 x 201 mm	4.5 kg



PAC400	Compatibility
P-Series Rotation Adapter	PDR, PNR & Other Q-Latch Mounts



CEILING DISPLAY MOUNTS

FUSION™ CEILING MOUNTS FEATURES



CENTRIS™ TILT TECHNOLOGY

Provides a continuous range of fingertip tilt from +5 to -20 degrees with four set locking points at 0, 5, 10 and 15 degrees to eliminate guess work when adjusting multiple screens.



ON/OFF COLUMN CONNECTION

Simple connection for ease of installation and service, particularly when installing in tight corners or near walls.



TOOL-FREE SCREEN ENGAGEMENT

Easily place screens and add optional padlock security.



FLEXIBILITY

Mount swivels to any preferred viewing angle before locking down with set screws.

XCM1U 60 - 90" LANDSCAPE CEILING MOUNT



For heavier displays with wider mounting patterns.

Weight Capacity	Dimensions (HxWxD)	Mounting Patterns (W,H)*	Tilt	Roll Adjust
113.4 kg	425 x 884 x 201 mm	200 x 100 - 800 x 400 mm	+5°, -20°	±3°

**Interface adapters for larger mounting hole patterns are available, please contact your customer service team for the correct part codes and to verify compatibility.*

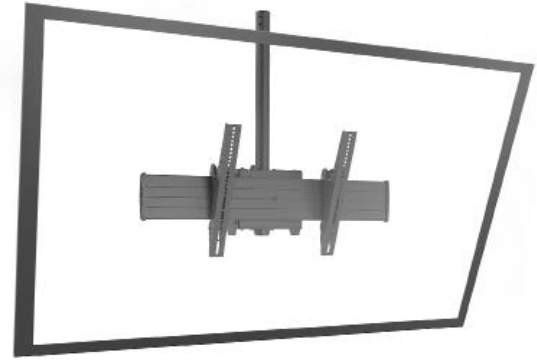

XCM7000 60 - 98" HEAVY-DUTY MOUNT



Dual pole drop provides needed support for single extra large and deep flat panel displays.

Weight Capacity	Dimensions (HxWxD)	Mounting Patterns (W,H)*	Tilt	Roll Adjust
136 kg	425 x 884 x 203 mm	200 x 100 - 800 x 400 mm	+7.5° / -20°	2" total height adjust at each head assembly

**Interface adapters for larger mounting hole patterns are available, please contact your customer service team for the correct part codes and to verify compatibility.*



LCM1U 45 - 70" LANDSCAPE CEILING MOUNT



Our most popular, feature-packed and versatile single ceiling mount fits most 32 - 60" displays. Add another for stacked configurations.

Weight Capacity	Dimensions (HxWxD)	Mounting Patterns (W,H)	Tilt	Roll Adjust	Color
56.7 kg	420 x 681 x 162 mm	200 x 100 - 616 x 400 mm	+5°, -20°	±3°	Ⓟ



LCM1U 45 - 70" PORTRAIT CEILING MOUNT



The portrait version of the LCM1U. Fits 32 - 60" displays.

Weight Capacity	Dimensions (HxWxD)	Mounting Patterns (W,H)	Tilt	Roll Adjust	Color
56.7 kg	826 x 529 x 162 mm	200 x 100 - 460 x 800 mm	+5°, -20°	±3°	B



MCM1U 32 - 55" CEILING MOUNT



The medium version of the LCM1U accommodates smaller mounting patterns as well as portrait and landscape orientations.

Weight Capacity	Dimensions (HxWxD)	Mounting Patterns (W,H)	Tilt	Roll Adjust	Color
56.7 kg	420 x 529 x 162 mm	200 x 100 - 460 x 400 mm	+5°, -20°	±3°	B



XCB1U 60 - 90" BACK-TO-BACK LANDSCAPE MOUNT



Back-to-back version of the XCM1U to mount two displays with wider mounting patterns.

Weight Capacity (per screen)	Dimensions (HxWxD)	Mounting Patterns (W,H)*	Tilt	Roll Adjust
90.7 kg	425 x 884 x 296 mm	200 x 100 - 800 x 400 mm	+5°, -20° for screens up to 38.8" tall	±3°

**Interface adapters for larger mounting hole patterns are available, please contact your customer service team for the correct part codes and to verify compatibility.*

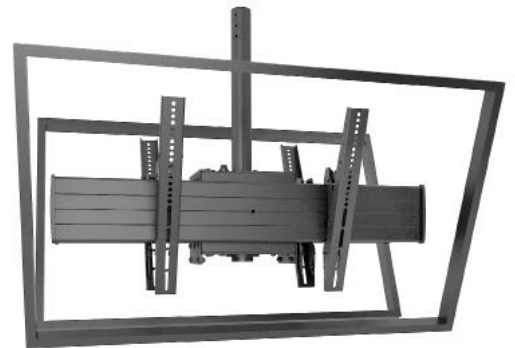

XCB7000 60 - 90" BACK-TO-BACK HEAVY-DUTY MOUNT



Dual pole drop provides needed support for back-to-back configurations of extra large and deep flat panel displays.

Weight Capacity (per screen)	Dimensions (HxWxD)	Mounting Patterns (W,H)*	Tilt	Roll Adjust
136 kg	425 x 884 x 300 mm	200 x 100-800 x 400 mm	+7.5° / -20°	2" total height adjust at each head assembly

*Interface adapters for larger mounting hole patterns are available, please contact your customer service team for the correct part codes and to verify compatibility.



LCB1U 45 - 70" BACK-TO-BACK LANDSCAPE MOUNT



The back-to-back version of the LCM1U for two total screens in a landscape configuration. Fits 32 - 60" displays.

Weight Capacity (per screen)	Dimensions per mount (HxWxD)	Mounting Patterns (W,H)	Tilt	Roll Adjust	Color
56.7 kg	420 x 681 x 259 mm	200 x 100 - 616 x 400 mm	+5°, -20°	±3°	B



MCB1U 32 - 55" BACK-TO-BACK LANDSCAPE



Back-to-back version of the MCM1U for two total screens in landscape or portrait configurations. Fits 26 - 50" displays.

Weight Capacity (per screen)	Dimensions per mount (HxWxD)	Mounting Patterns (W,H)	Tilt	Roll Adjust	Color
56.7 kg	419 x 529 x 259 mm	200 x 100 - 460 x 400 mm	+5°, -20°	±3°	B

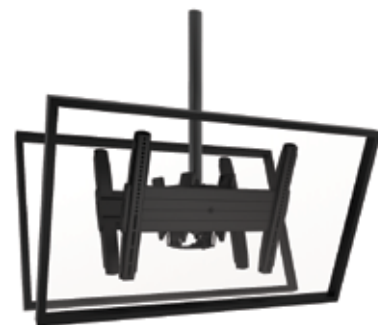

LCM1X2U 45 - 60" STACKED LANDSCAPE



This solution includes two LCM1U mounts and a 121.9 cm perforated CPA column for stacking two screens on the same column.

Weight Capacity (per screen)	Dimensions per mount (HxWxD)	Mounting Patterns (W,H)	Tilt	Roll Adjust	Color
56.7 kg	420 x 681 x 162 mm	200 x 100 - 616 x 400 mm	+5°, -20°	±3°	B

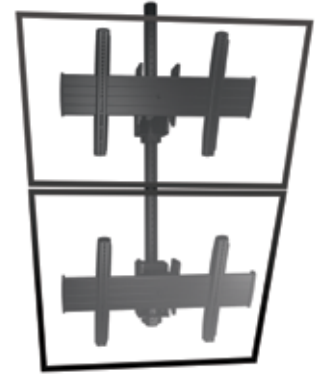

MCM1X2U 32 - 50" STACKED LANDSCAPE



Stacked solution includes two MCM1U mounts and a 121.9 cm perforated CPA in a 1 wide x 2 tall configuration.

Weight Capacity (per screen)	Dimensions per mount (HxWxD)	Mounting Patterns (W,H)	Tilt	Roll Adjust	Color
56.7 kg	419 x 529 x 162 mm	200 x 100 - 460 x 400 mm	+5°, -20°	±3°	B



LCB1X2U 45 - 60" BACK-TO-BACK STACKED



The back-to-back version of the LCM1x2U stacks two screens per side for four total screens and a 121.9 cm perforated CPA column.

Weight Capacity (per screen)	Dimensions per mount (HxWxD)	Mounting Patterns (W,H)	Tilt	Roll Adjust	Color
45.3 kg	420 x 681 x 259 mm	200 x 100 - 616 x 400 mm	+5°, -20°	±3°	B



MCB1X2U 32 - 50" BACK-TO-BACK STACKED



Back-to-back version of the MCM1x2U stacks two screens per side for four total screens and a 121.9 cm perforated CPA column.

Weight Capacity (per screen)	Dimensions per mount (HxWxD)	Mounting Patterns (W,H)	Tilt	Roll Adjust	Color
45.3 kg	420 x 529 x 259 mm	200 x 100 - 460 x 400 mm	+5°, -20°	±3°	B



LCM4U 45 - 65" QUAD MOUNT



Allows four screens to be installed on a single column drop for 360° viewing capabilities. Comes with Fusion interfaces.

Weight Capacity (per screen)	Dimensions per mount (HxWxD)	Mounting Patterns (W,H)	Tilt	Roll Adjust	Color
38 kg	475 x 1422 x 1422 mm	200 x 200 - 600 x 400 mm	+5°, -20°	±3°	B

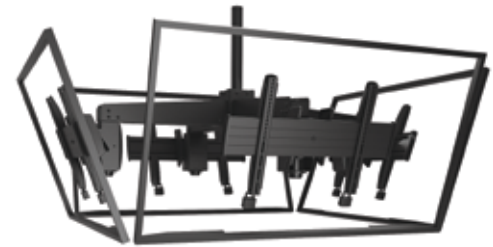

LCM3U 45 - 65" TRIPLE MOUNT



Allows three screens to be installed on a single column drop for 360° viewing capabilities. Comes with Fusion interfaces.

Weight Capacity (per screen)	Dimensions per mount (HxWxD)	Mounting Patterns (W,H)	Tilt	Roll Adjust	Color
57 kg	462 x 1184 x 1184 mm	200 x 200 - 600 x 400 mm	+5°, -20°	±3°	B

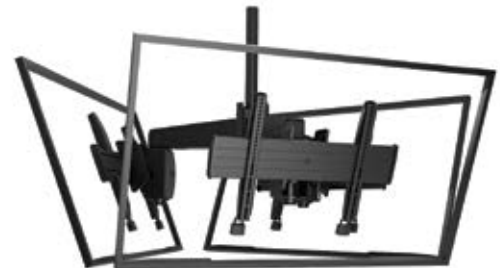

FUSION™ VIDEO WALL

FEATURES



CONTROLZONE™ LEVELING
Allows for 51 mm of height adjustment at each mounting box plus 25 mm increments along each column.



INDEPENDENT ADJUSTMENT
Separate knobs for micro-height and plumb adjustment help to easily align displays without tools.



INFINITE SCREEN POSITIONING
Infinite vertical and lateral shift adjustments allow for tight display rows and columns.



CABLE MANAGEMENT
FCACLIPS can be added at any point along the crossbars to create anchor points for easy cable management.



ADD EXTENSION
FCAX accessories increase rail length for larger displays, up to 152 cm.



INDEPENDENT ADJUSTMENT



INFINITE SCREEN POSITIONING

LCM2X2U LANDSCAPE VIDEO WALL



The versatile and popular landscape 2 wide x 2 tall configuration fits well in most digital signage applications. Fits 40 - 55" displays.

Weight Capacity (per screen)	Dimensions (HxWxD)	Mounting Patterns (W,H)	Manual Height Adjust	Micro Height Adjust
56.7 kg	1389 x 1851 x 368 mm	Any width x 100 - 400 mm	25 mm	51 mm

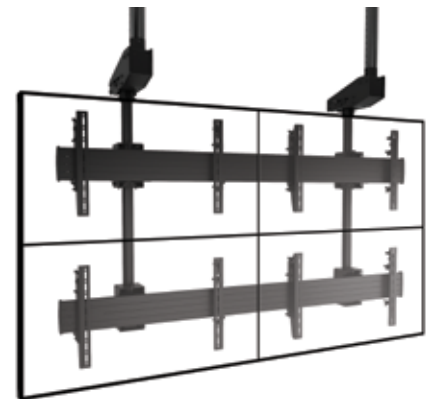

LCM2X2UP PORTRAIT VIDEO WALL



A portrait version to mount video walls 2 wide x 2 tall. Fits 40 - 55" displays.

Weight Capacity (per screen)	Dimensions (HxWxD)	Mounting Patterns (W,H)	Manual Height Adjust	Micro Height Adjust
56.7 kg	1996 x 1189 x 368 mm	100 - 800 mm x Any Height	25 mm	51 mm



LCM3X2U LANDSCAPE VIDEO WALL



Create video walls in landscape orientation 3 wide x 2 tall. Fits 40 - 55" displays.

Weight Capacity (per screen)	Dimensions (HxWxD)	Mounting Patterns (W,H)	Manual Height Adjust	Micro Height Adjust
56.7 kg	1389 x 2766 x 368 mm	Any width x 100 - 400 mm	25 mm	51 mm

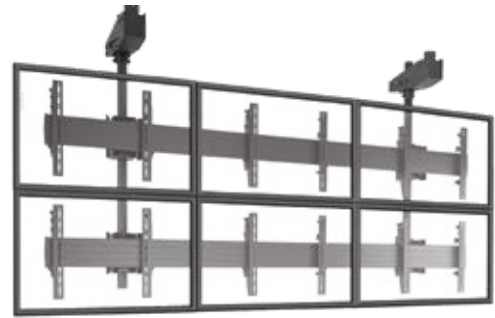

LCM3X2UP PORTRAIT VIDEO WALL



A portrait version to mount video walls 3 wide x 2 tall. Fits 40 - 55" displays.

Weight Capacity (per screen)	Dimensions (HxWxD)	Mounting Patterns (W,H)	Manual Height Adjust	Micro Height Adjust
56.7 kg	1996 x 1748 x 368 mm	100 - 800 mm x Any Height	25 mm	51 mm



LCM3X3U LANDSCAPE VIDEO WALL







The landscape 3 wide x 3 tall configuration can be combined with other ceiling mounts to create longer walls. Fits 40 - 55" displays.

Weight Capacity (per screen)	Dimensions (HxWxD)	Mounting Patterns (W,H)	Manual Height Adjust	Micro Height Adjust
38.5 kg	1996 x 2763 x 368 mm	Any width x 100 - 400 mm	25 mm	51 mm



FUSION™ MENU BOARD FEATURES

-  **CONTROLZONE™ LEVELING**
Allows for 51 mm of height adjustment at each mounting box.
-  **CENTRIS™ TILT TECHNOLOGY**
Screens stay where you place them for effortless multi-screen alignment.
-  **TOOL-FREE SCREEN ENGAGEMENT**
Easily place screens and add optional padlock security.
-  **LATERAL SHIFT**
Post-installation lateral shift allows screens to slide apart or together for easy maintenance and perfect alignment.
-  **ADD EXTENSION**
FCAX accessories increase rail length for larger displays, up to 152 cm.



CONTROLZONE LEVELING



CENTRIS TILT TECHNOLOGY

LCM2X1U LANDSCAPE MENU BOARD



This classic menu board configuration is two screens across. Create longer menu boards by combining mounts. Fits 40 - 55" displays.

Weight Capacity (per screen)	Dimensions (HxWxD)	Mounting Patterns (W,H)	Micro Height Adjust	Tilt
56.7 kg	427 x 1851 x 201 mm	Any width x 100 - 400 mm	N/A	+5°, -20°



LCM2X1UP PORTRAIT MENU BOARD



The portrait version of the LCM2X1U. Fits 40 - 55" displays.

Weight Capacity (per screen)	Dimensions (HxWxD)	Mounting Patterns (W,H)	Micro Height Adjust	Tilt
56.7 kg	826 x 1190 x 201 mm	100 - 800 mm x Any Height	N/A	+5°, -20°

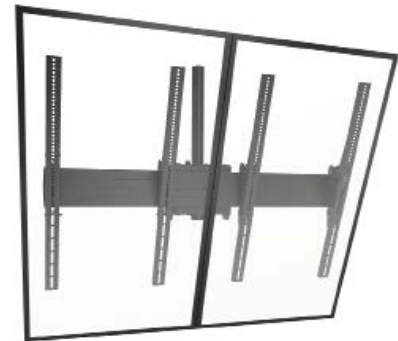

LCM3X1U LANDSCAPE MENU BOARD



This classic menu board configuration is three screens across. Create longer menu boards by combining mounts. Fits 40 - 55" displays.

Weight Capacity (per screen)	Dimensions (HxWxD)	Mounting Patterns (W,H)	Micro Height Adjust	Tilt
56.7 kg	425 x 2766 x 201 mm	Any width x 100 - 400 mm	51 mm	+5°, -20°

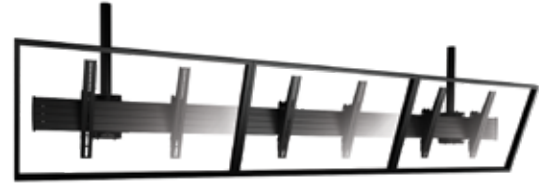

LCM3X1UP PORTRAIT MENU BOARD



The portrait of the LCM3X1U. Fits 40 - 55" displays.

Weight Capacity (per screen)	Dimensions (HxWxD)	Mounting Patterns (W,H)	Micro Height Adjust	Tilt
56.7 kg	826 x 1750 x 201 mm	100 - 800 mm x Any Height	51 mm	+5°, -20°

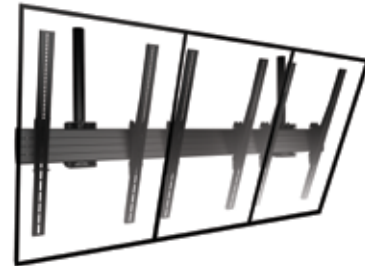

LCB2X1U BACK-TO-BACK LANDSCAPE



Mount two screens back-to-back in landscape orientation for four total screens. Fits 40 - 55" displays.

Weight Capacity (per screen)	Dimensions (HxWxD)	Mounting Patterns (W,H)	Micro Height Adjust	Tilt
45.4 kg	425 x 1851 x 296 mm	Any width x 100 - 400 mm	N/A	+5°, -20°

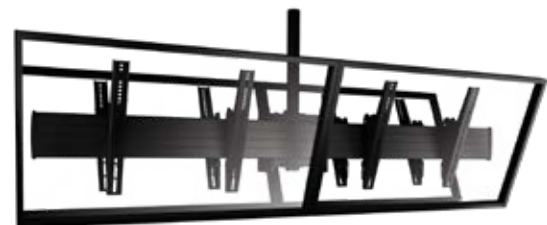

LCB2X1UP BACK-TO-BACK PORTRAIT



The portrait version of the LCB2X1U. Fits 40 - 55" displays.

Weight Capacity (per screen)	Dimensions (HxWxD)	Mounting Patterns (W,H)	Micro Height Adjust	Tilt
45.4 kg	826 x 1190 x 296 mm	100 - 800 mm x Any Height	N/A	+5°, -20°



LCB3X1U BACK-TO-BACK LANDSCAPE



Mount three screens back-to-back in landscape orientation for six total screens. Fits 40 - 55" displays.

Weight Capacity (per screen)	Dimensions (HxWxD)	Mounting Patterns (W,H)	Micro Height Adjust	Tilt
56.7 kg	425 x 2763 x 292 mm	Any width x 100 - 400 mm	51 mm	+5°, -20°



LCB3X1UP BACK-TO-BACK PORTRAIT



The portrait version of the LCB3X1U. Fits 40 - 55" displays.

Weight Capacity (per screen)	Dimensions (HxWxD)	Mounting Patterns (W,H)	Micro Height Adjust	Tilt
56.7 kg	826 x 1748 x 292 mm	100 - 800 mm x Any Height	51 mm	+5°, -20°

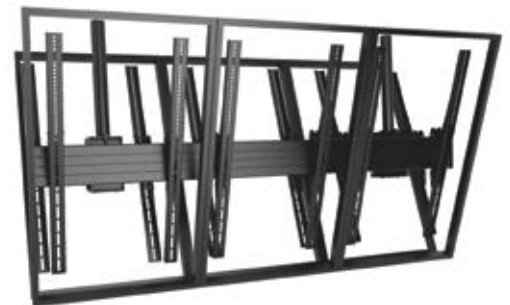

CEILING DISPLAY MOUNT ACCESSORIES



CPA116	Weight Capacity	Color
Pin Connection Flat Ceiling Plate	34 kg	Ⓜ ⓑ



CPA330	Weight Capacity
CPA Offset Ceiling Plate	226.8 kg



CPA395	Weight Capacity
CPA Angled Ceiling Plate	226.8 kg



CPA380	Weight Capacity
Truss Clamp, CPA Compatible	113.4 kg



CPA263	Weight Capacity
CPA column to CPA column connector	226.8 kg



CPA262	Weight Capacity
CPA to NPT Column Connection Adapter (contains male 1-1/2" NPT threads and accepts Chief CPA columns)	113.4 kg
Model	Color
CPA262	ⓑ (shown)
CPA262S	Ⓢ



CPA264	Weight Capacity
NPT to CPA Column Connection Adapter (contains female 1-1/2" NPT threads and accepts Chief's CPA columns)	226.8 kg



CPA351	Compatibility	Weight Capacity
Floor-to-Ceiling Low-Profile Collar Plate	CPAE & CMS Columns	227 kg per pole



CPA353	Compatibility	Weight Capacity
Floor-to-Ceiling Clamp-Style Collar Plate	CPAE & CMS Columns	227 kg per pole



CPA Columns	Weight Capacity	Color
Fixed, pin-connection extension columns available in black, silver and white†	226.8 kg	Ⓜ ⓑ
Model	Length	
CPAE030	300 mm	
CPAE080	800 mm	
CPAE100	1000 mm	
CPAE150	1500 mm	
CPAE300	3000 mm	
† All part numbers listed are black. To order alternate colors add a W (white) to the end of the part number.		



CMA274	Compatibility
Quick-Snap Cable Cover	CPA Columns
Model	Color
CMA274	ⓑ (shown)
CMA274W	Ⓜ



CMA275	Compatibility
Quick-Snap Cable Covers (3 pack)	CPA Columns



CMA340	Compatibility
Stabilization Kit for Columns	CPA Columns

FUSION™ VIDEO WALL, MENU BOARD & CEILING MOUNT ACCESSORIES



FCAX08/14/20		Compatibility
Video Wall Extension Brackets		Fusion Video Wall & Menu Board Ceiling Mounts
Model	Length	
FCAX08	203 mm	
FCAX14	356 mm	
FCAX20	508 mm	



FCAC	Compatibility
Menu Board Connector*	Fusion Ceiling-Mounted Menu Boards

* For alignment and aesthetics only - not for bearing load.



FCA3U	Compatibility
Triple Ceiling Mount Adapter	Allows for integration of different mount heads like the LCM1U, MCM1U, RLC1, RMC1 and JHS mounts



FCA4U	Compatibility
Quad Ceiling Mount Adapter	Allows for integration of different mount heads like the LCM1U, MCM1U, RLC1, RMC1 and JHS mounts



FCA800/ FCA801		Compatibility
Above/Below Shelf, Large* Displays		Fusion Fixed & Tilt Wall, Freestanding & Ceiling Mounts
Model	Size	Weight Capacity
FCA800	203 mm	9.1 kg
FCA801	355 mm	9.1 kg

*Typical screen size: 46-70".



FCA810/ FCA811		Compatibility
Above/Below Shelf, XL* Displays		Fusion Fixed & Tilt Wall, Freestanding & Ceiling Mounts
Model	Size	Weight Capacity
FCA810	203 mm	9.1 kg
FCA811	355 mm	9.1 kg

* Typical screen size: 70-100".



FCA820/ FCA821		Compatibility
Fusion Center Camera Shelf		Fusion Ceiling, Freestanding and Wall Mounts
Model	Size	Weight Capacity
FCA820	203 mm	9.1 kg
FCA821	355 mm	9.1 kg



FCA802/ FCA812		Compatibility
Fusion Lower Component Shelf		All Fusion Series Mounts
Model	Size	Weight Capacity
FCA802	Large Displays	9.1 kg
FCA812	XL Displays	9.1 kg



FCA510/515		Compatibility
Storage Accessories		All Fusion Ceiling & Freestanding Mounts
Model	Dimensions (HxWxD)	
FCA510	267 x 267 x 76 mm	
FCA515	394 x 394 x 114 mm	



FCA520	Max Equipment Depth	Compatibility
Universal Clamp Kit (Qty 2)	83 mm	All Fusion Ceiling & Freestanding Mounts

FUSION™ VIDEO WALL, MENU BOARD & CEILING MOUNT ACCESSORIES



FCA830/ FCA840		Compatibility
Center Channel Speaker Adapter		Fusion Fixed & Tilt Wall, Freestanding & Ceiling Mounts
Model	Typical Screen Size	Weight Capacity
FCA830	52 - 80"	9.1 kg
FCA840	70 - 100"+	9.1 kg



FCA831/ FCA841		Compatibility
Center Channel Speaker Adapter		Fusion Fixed & Tilt Wall, Freestanding & Ceiling Mounts
Model	Typical Screen Size	Weight Capacity
FCA831	42 - 70"	4.5 kg/side
FCA841	50 - 95"	4.5 kg/side



FCACLIPS	Compatibility
Anchor Points for Zip Ties (Qty 10)	All Fusion Ceiling & Freestanding Mounts





FLOOR TO CEILING APPLICATIONS CHOOSING THE RIGHT SOLUTION

There are a few things to consider when choosing your Chief floor-to-ceiling solution

LOAD BEARING: FLOOR VS. CEILING

Both the CPA351 and CPA353 have a weight capacity of 227 kg and should be used at the base of the assembly in all floor-to-ceiling applications. What gets used at the ceiling depends on whether the floor or ceiling is bearing the load.

In floor-load-bearing installations, the CPA351 and CPA353 can be used at both the floor and the ceiling connections.

In ceiling-load-bearing installations, standard Chief ceiling plates should be used at the ceiling connection, with the CPA351 or CPA353 being used at the floor.

PROFILE VS. PRECISION

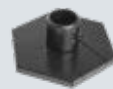

CPA351

When a low profile is the priority, choose the CPA351. The aesthetic cover is just 14 mm tall and blends well into many environments.



CPA353

When ease of install is the priority, choose the CPA353. The clamp-style profile provides a buffer for column length, resulting in a more forgiving installation.

CONFIGURATION

Chief's floor-to-ceiling accessories can be used with CPAE or CMS columns, and combined with Fusion single display or back-to-back ceiling mount. Displays can be stacked and in portrait or landscape orientations.

OTHER CEILING, TRUSS & POLE MOUNTS

TPSU 42 - 71" FIXED TRUSS & POLE MOUNT



This fixed solution for truss and pole mounting supports portrait and landscape orientations with the Q-Latch™ mounting system.

Weight Capacity	Dimensions (HxWxD)	Mounting Patterns (W,H)	Truss Systems	Orientation
68 kg	412 x 433 x 27 mm	200 x 200 - 862 x 517 mm	356 mm (OD)	Landscape, Portrait



TPMU 42 - 71" TILT POLE MOUNT



Mounts to poles with multiple tilt adjustment options along with portrait and landscape orientations with Q-Latch™ mounting system.

Weight Capacity	Dimensions (HxWxD)	Mounting Patterns (W,H)	Tilt	Tilt Locking Points	Orientation
68 kg	412 x 433 x 86 mm	200 x 200 - 862 x 517 mm	+5°,-15°	0°, 5°, 10° and 15°	Landscape, Portrait



JPPU 26 - 45" PIVOT/TILT POLE MOUNT



Pole clamp supports portrait and landscape orientations with Centris™ fingertip tilt in all directions.

Weight Capacity	Dimensions (HxWxD)	Mounting Patterns (W,H)	Pivot/Tilt	Pole Diameter	Color
34 kg	189 x 152 x 89 mm	100 x 100 - 400 x 400 mm	±15°	38 - 51 mm	S B



KOP100B SINGLE MONITOR POLE MOUNT



Easily attaches a monitor to a pole and provides smooth pivot and tilt adjustment.

Column Diameter Range	Weight Capacity	Mounting Patterns (W,H)	Tilt	Min. Depth From Pole	Typical Screen Size	Color
38 - 48 mm	18.14 kg	75 x 75 - 100 x 100 mm	+75°, -10°	66 mm	10 - 30"	B



OTHER CEILING MOUNT ACCESSORIES



PAC715/716		Compatibility
Video Conferencing Camera Shelves - Above or Below		TPS, TPM, TPP & Other Q-Latch Mounts
Model	Dimensions (WxD)	Weight Capacity
PAC715	229 x 223 mm	4.5 kg
PAC716	356 x 301 mm	4.5 kg



CPA351	Compatibility	Weight Capacity
Floor-to-Ceiling Low-Profile Collar Plate	CPAE & CMS Columns	227 kg per pole







CPA353	Compatibility	Weight Capacity
Floor-to-Ceiling Clamp-Style Collar Plate	CPAE & CMS Columns	227 kg per pole



FREESTANDING DISPLAY MOUNTS

FUSION™ VIDEO WALL FEATURES

-  **INDEPENDENT, TOOL-FREE ADJUSTMENT**
Separate knobs for micro-height and plumb adjustment help to easily align displays without tools.
-  **CONTINUOUS ADJUSTMENT**
Continuous vertical and lateral adjustments allow for tight display rows and columns.
-  **CABLE MANAGEMENT**
FCA CLIPS can be added at any point along the crossbars to create anchor points for easy cable management.
-  **INSTALLATION OPTIONS**
Configurations come in cart or bolt-down applications to meet temporary or permanent signage needs.
-  **60" OPTION** **ADD EXTENSION**
FCAX accessories increase rail length for larger displays, up to 60" (152 cm).



INDEPENDENT
ADJUSTMENT

LVM3X3U 42 - 46" LANDSCAPE CART



The landscape-oriented, 3 wide x 3 tall configuration with smooth rolling casters for large, temporary video walls.

Weight Capacity (per screen)	Dimensions (HxWxD)	Mounting Patterns (W,H)	Height Adjust (per screen)	Plumb Adjust
45.4 kg	2350 x 2743 x 1026 mm	Any Width x 100 - 400 mm	19 mm	19 mm



LBM3X3U 42 - 46" LANDSCAPE BOLT-DOWN



The landscape-oriented, 3 wide x 3 tall configuration for large, bolt-down video walls.

Weight Capacity (per screen)	Dimensions (HxWxD)	Mounting Patterns (W,H)	Height Adjust (per screen)	Plumb Adjust
45.4 kg	2310 x 2763 x 239 mm	Any Width x 100 - 400 mm	19 mm	19 mm

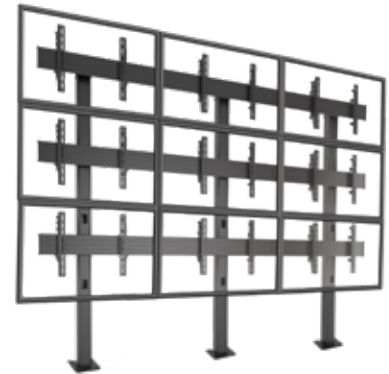

LVM3X2U 42 - 46" LANDSCAPE CART



The landscape-oriented, 3 wide x 2 tall configuration with smooth rolling casters for large, temporary video walls.

Weight Capacity (per screen)	Dimensions (HxWxD)	Mounting Patterns (W,H)	Height Adjust (per screen)	Plumb Adjust
56.7 kg	1893 x 2743 x 1026 mm	Any Width x 100 - 400 mm	19 mm	19 mm



LVM3X2UP 42 - 46" PORTRAIT CART



The portrait version of the LVM3X2U.

Weight Capacity (per screen)	Dimensions (HxWxD)	Mounting Patterns (W,H)	Height Adjust (per screen)	Plumb Adjust
45.4 kg	2710 x 1727 x 1026 mm	100 - 800 mm x Any Height	19 mm	19 mm



LBM3X2U 42 - 46" LANDSCAPE BOLT-DOWN

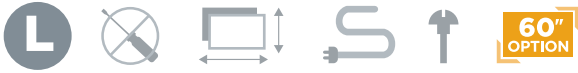

The landscape-oriented, 3 wide x 2 tall configuration for large, bolt-down video walls.

Weight Capacity (per screen)	Dimensions (HxWxD)	Mounting Patterns (W,H)	Height Adjust (per screen)	Plumb Adjust
56.7 kg	1852 x 2766 x 239 mm*	Any Width x 100 - 400 mm	19 mm	19 mm

* Height is increased with FCABX accessories.

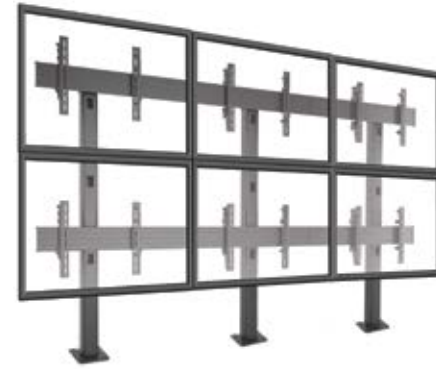

LBM3X2UP 42 - 46" PORTRAIT BOLT-DOWN

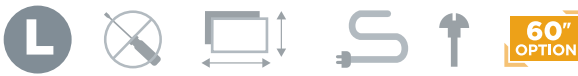

The portrait version of the LBM3X2U.

Weight Capacity (per screen)	Dimensions (HxWxD)	Mounting Patterns (W,H)	Height Adjust (per screen)	Plumb Adjust
45.4 kg	2504 x 1727 x 244 mm*	100 - 800 mm x Any Height	19 mm	19 mm

* Height is increased with FCABX accessories.



LVM3X1UP 42 - 46" PORTRAIT CART



The portrait-oriented, 3 wide x 1 tall configuration with smooth rolling casters for temporary menu boards.

Weight Capacity (per screen)	Dimensions (HxWxD)	Mounting Patterns (W,H)	Height Adjust (per screen)	Plumb Adjust
56.7 kg	2253 x 1727 x 1026 mm	100 - 800 mm x Any Height	19 mm	19 mm



LBM3X1UP 42 - 46" PORTRAIT BOLT-DOWN

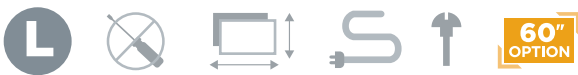

The portrait-oriented, 3 wide x 1 tall configuration for bolt-down menu boards.

Weight Capacity (per screen)	Dimensions (HxWxD)	Mounting Patterns (W,H)	Height Adjust (per screen)	Plumb Adjust
56.7 kg	2047 x 1727 x 244 mm*	100 - 800 mm x Any Height	19 mm	19 mm

* Height is increased with FCABX accessories.



LBM1X3U 42 - 65" LANDSCAPE BOLT-DOWN



Landscape-oriented, 1 wide x 3 tall configuration ideal for retail environments.

Weight Capacity (per screen)	Dimensions (HxWxD)	Mounting Patterns (W,H)	Height Adjust (per screen)	Plumb Adjust
56.7 kg	2145 x 914 x 191 mm	100 x 100 mm - 900 x 400 mm	19 mm	19 mm

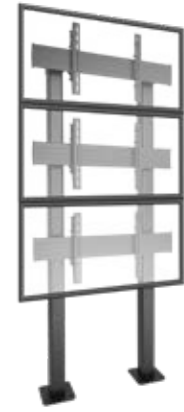

LVM2X2U 42 - 50" LANDSCAPE CART



Our top performing, landscape-oriented, 2 wide x 2 tall configuration with smooth rolling casters for large, temporary video walls.

Weight Capacity (per screen)	Dimensions (HxWxD)	Mounting Patterns (W,H)	Height Adjust (per screen)	Plumb Adjust
56.7 kg	2045 x 1842 x 1026 mm	Any Width x 100 - 400 mm	19 mm	19 mm



LVM2X2UP 42 - 50" PORTRAIT CART



The portrait version of the LVM2X2U.

Weight Capacity (per screen)	Dimensions (HxWxD)	Mounting Patterns (W,H)	Height Adjust (per screen)	Plumb Adjust
45.4 kg	2710 x 1168 x 1026 mm	100 - 800 mm x Any Height	19 mm	19 mm



LBM2X2U 42 - 50" LANDSCAPE BOLT-DOWN



The landscape-oriented, 2 wide x 2 tall configuration for bolt-down video walls.

Weight Capacity (per screen)	Dimensions (HxWxD)	Mounting Patterns (W,H)	Height Adjust (per screen)	Plumb Adjust
56.7 kg	1852 x 1852 x 239 mm*	Any Width x 100 - 400 mm	19 mm	19 mm

* Height is increased with FCABX accessories.

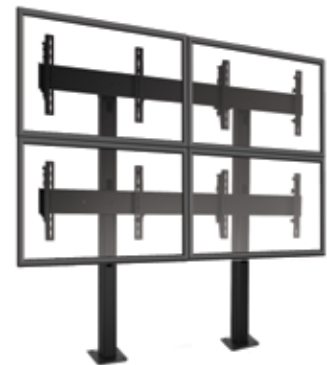

LBM2X2UP 42 - 50" PORTRAIT BOLT-DOWN



The portrait version of the LBM2X2U.

Weight Capacity (per screen)	Dimensions (HxWxD)	Mounting Patterns (W,H)	Height Adjust (per screen)	Plumb Adjust
45.4 kg	2504 x 1168 x 240 mm*	100 - 800 mm x Any Height	19 mm	19 mm

* Height is increased with FCABX accessories.



LBM1X2U 42 - 80" LANDSCAPE BOLT-DOWN



Landscape-oriented, 1 wide x 2 tall configuration ideal for retail environments.

Weight Capacity (per screen)	Dimensions (HxWxD)	Mounting Patterns (W,H)	Height Adjust (per screen)	Plumb Adjust
56.7 kg	1689 x 914 x 191 mm	100 x 100 mm - 900 x 400 mm	19 mm	19 mm



LBM1X2UP 42 - 80" PORTRAIT BOLT-DOWN



Portrait-oriented, 1 wide x 2 tall configuration ideal for retail environments.

Weight Capacity (per screen)	Dimensions (HxWxD)	Mounting Patterns (W,H)	Height Adjust (per screen)	Plumb Adjust
56.7 kg	2145 x 914 x 191 mm	100 x 100 mm - 800 x 900 mm	19 mm	19 mm



XBM1U 42 - 80" LANDSCAPE BOLT-DOWN



Landscape-oriented, single screen configuration for securing XL displays in prominent locations.

Weight Capacity (per screen)	Dimensions (HxWxD)	Mounting Patterns (W,H)*	Height Adjust (per screen)	Plumb Adjust
113 kg	2143 x 914 x 191 mm	100 x 100 mm - 900 x 400 mm	19 mm	19 mm

*Interface adapters for larger mounting hole patterns are available, please contact your customer service team for the correct part codes and to verify compatibility.



XBM1UP 42 - 80" PORTRAIT BOLT-DOWN



Portrait-oriented, single screen configuration for securing XL displays in prominent locations.

Weight Capacity (per screen)	Dimensions (HxWxD)	Mounting Patterns (W,H)	Height Adjust (per screen)	Plumb Adjust
113 kg	2083 x 914 x 191 mm	100 x 100 mm - 800 x 900 mm	19 mm	19 mm



FUSION™ VIDEO WALL ACCESSORIES

60" OPTION



FCAX08/14/20		Compatibility
Video Wall Extension Brackets		Fusion Video Wall & Menu Board Ceiling Mounts
Model	Length	
FCAX08	203 mm	
FCAX14	356 mm	
FCAX20	508 mm	



FCA800/ FCA801		Compatibility
Above/Below Shelf, Large* Displays		Fusion Fixed & Tilt Wall, Freestanding & Ceiling Mounts
Model	Size	Weight Capacity
FCA800	203 mm	9.1 kg
FCA801	355 mm	9.1 kg

*Typical screen size: 46-70".

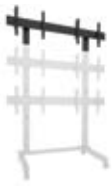

FCA2X1U		Compatibility
LVM & LBM 2x1 Accessory		LVM2X2U, LBM2X2U



FCA810/ FCA811		Compatibility
Above/Below Shelf, XL* Displays		Fusion Fixed & Tilt Wall, Freestanding & Ceiling Mounts
Model	Size	Weight Capacity
FCA810	203 mm	9.1 kg
FCA811	355 mm	9.1 kg

*Typical screen size: 70-100".



FCA3X1U		Compatibility
LVM & LBM 3x1 Accessory		LVM3X2U, LBM3X2U



FCA820/ FCA821		Compatibility
Fusion Center Camera Shelf		Fusion Ceiling, Freestanding and Wall Mounts
Model	Size	Weight Capacity
FCA820	203 mm	9.1 kg
FCA821	355 mm	9.1 kg



FCABX18		Compatibility
Fusion LBM Video Wall Height Extensions - 457 mm (18")		Fusion LBM Bolt-Down Mounts



FCABX36		Compatibility
Fusion LBM Video Wall Height Extensions - 914 mm (36")		Fusion LBM Bolt-Down Mounts



FCA510/515		Compatibility
Storage Accessories		All Fusion Ceiling & Freestanding Mounts
Model	Dimensions (HxWxD)	
FCA510	267 x 267 x 76 mm	
FCA515	394 x 394 x 114 mm	



FCA802/ FCA812		Compatibility
Component Shelf, Large and XL Displays		Fusion Fixed & Tilt Wall, Freestanding & Ceiling Mounts
Model	Typical Screen Size	Weight Capacity
FCA802	46 - 70"	9.1 kg
FCA812	70 - 100"	9.1 kg



FCA520		Max Equipment Depth	Compatibility
Universal Clamp Kit (Qty 2)		83 mm	All Fusion Ceiling & Freestanding Mounts

FREESTANDING DISPLAY MOUNT ACCESSORIES

FUSION™ VIDEO WALL ACCESSORIES



FCA830/ FCA840		Compatibility
Center Channel Speaker Adapter		Fusion Fixed & Tilt Wall, Freestanding & Ceiling Mounts
Model	Typical Screen Size	Weight Capacity
FCA830	52 - 80"	9.1 kg
FCA840	70 - 100"+	9.1 kg



FCA831/ FCA841		Compatibility
Center Channel Speaker Adapter		Fusion Fixed & Tilt Wall, Freestanding & Ceiling Mounts
Model	Typical Screen Size	Weight Capacity
FCA831	42 - 70"	4.5 kg/side
FCA841	50 - 95"	4.5 kg/side







FCACLIPS	Compatibility
Cable Quick Ties (Qty 10)	All Fusion Ceiling & Freestanding Mounts



FCA776	Compatibility
LVM Leveling Feet	Fusion LVM Video Wall Mounts

FUSION™ CARTS & STANDS

FEATURES

-  **HEIGHT ADJUST**
Turn knob allows a single user to raise or lower the viewing height of the screen by hand or power drill.
-  **CABLE MANAGEMENT**
Flexible cable covers allow access at any point along the column while concealing cables for a clean installation.
-  **CUSTOMIZABLE**
A host of available accessories allows for customized solutions to meet any need.
-  **LOCKING CASTORS**
Smooth rolling and lockable castors make transportation and positioning easy.

XVAU 37 - 70" VIDEO CONFERENCE CART



Aesthetically designed cart with two-toned finish ships fully assembled with 11 RUs of storage space for rack mountable and non-rack mountable AV components. Dual display adapter available, see page 86.

Weight Capacity	Dimensions (HxWxD)	Mounting Patterns (WxH)	Center of Display to Floor Range	Tilt	Color
113 kg	1395 x 986 x 737 mm	200 x 200 - 800 x 400 mm	1064 - 1280 mm	±2.5°	



XPA1U 55 - 100"+ HEAVY-DUTY CART



Includes magnetic covers for easy equipment storage and supports heavy displays up to 136 kg. Great for video conferencing when used with the dual display accessory. Dual display adapter available, see page 86.

Weight Capacity	Dimensions (HxWxD)	Mounting Patterns (W,H)*	Center of Display to Floor Range	Tilt	Color
136 kg	1877 x 1472 x 878 mm	200 x 200 - 800 x 400 mm	1213 - 1662 mm	±5°	

**Interface adapters for larger mounting hole patterns are available, please contact your customer service team for the correct part codes and to verify compatibility.*



XFA1U 55 - 100"+ HEAVY-DUTY FLOOR SUPPORT



An ideal solution for applications where the wall structure can't carry the weight. Sleek design gives a professional feel that fits well in corporate and classroom environments. Dual display adapter available, see page 86.

Weight Capacity	Dimensions (HxWxD)	Mounting Patterns (W,H)*	Center of Display to Floor Range	Tilt	Color
136 kg	1738 x 936 x 226 mm	200 x 200 - 800 x 400 mm	1066 - 1515 mm	±15°	

**Interface adapters for larger mounting hole patterns are available, please contact your customer service team for the correct part codes and to verify compatibility.*



LPAU 40 - 80" HEIGHT-ADJUSTABLE CART



This popular, aesthetically designed cart works well in classrooms and corporate environments.

Weight Capacity	Dimensions (HxWxD)	Mounting Patterns (W,H)	Center of Display to Floor Range	Tilt	Color
90.7 kg	1801 x 1143 x 844 mm	200 x 200 - 800 x 400 mm	1271 x 1779 mm	±5°	S B



LFAU 40 - 80" HEIGHT-ADJUSTABLE STAND



The stand version of the LPAU for semi-permanent installations.

Weight Capacity	Dimensions (HxWxD)	Mounting Patterns (W,H)	Height Adjust	Tilt	Color
90.7 kg	1839 x 968 x 777 mm	200 x 200 - 800 x 400 mm	1130 - 1640 mm	±5°	S B



MPAU 37 - 55" HEIGHT-ADJUSTABLE CART



A smaller version of the LPAU for narrower and shorter mounting patterns.

Weight Capacity	Dimensions (HxWxD)	Mounting Patterns (W,H)	Center of Display to Floor Range	Tilt	Color
56.7 kg	1979 x 1214 x 813 mm	200 x 100 - 600 x 400 mm	1270 - 1770 mm	±5°	S B



MFAU 37 - 55" HEIGHT-ADJUSTABLE STAND



A smaller version of the LFAU for narrower and shorter mounting patterns.

Weight Capacity	Dimensions (HxWxD)	Mounting Patterns (W,H)	Center of Display to Floor Range	Tilt	Color
56.7 kg	1839 x 968 x 777 mm	200 x 100 - 600 x 400 mm	1130 - 1630 mm	±5°	S B





FUSION™ DYNAMIC HEIGHT ADJUST CARTS & STANDS

FEATURES

 **DYNAMIC HEIGHT ADJUST**
Instantly raise and lower the display up to 400 mm by hand, no electricity needed. Starting height can be set at 76 mm intervals over a span of 305 mm.

 **INTEGRATED STORAGE**
Magnetic covers provide easy access and storage of AV equipment.

 **CLICKCONNECT™**
Tool-less latching makes an audible click when a Fusion mount is safely engaged with the screen.

 **CUSTOMIZABLE**
A host of available accessories allows for customized solutions to meet any need.

LPD1U & MPD1U DYNAMIC CARTS



Fast, easy height adjustment increases access to interactive displays. Mobile cart design includes easy grip handles and display stabilizers for easy transportation.

Model	Weight Capacity Range	Vertical Travel	Travel Range Options	Mounting Pattern Range
LPD1U	57 - 80 kg	400 mm	92.3 - 137.2 cm; 105 - 144.5 cm; 112.5 - 152.4 cm; 120.1 - 160 cm; 127.8 - 167.6 cm	200 x 200 - 800 x 400 mm
MPD1U	30 - 59 kg			



LFD1U & MFD1U DYNAMIC FLOOR SUPPORT MOUNTS



Fast, easy height adjustment increases access to interactive displays. Ideal for applications where the wall structure can't carry the weight.

Model	Weight Capacity Range	Vertical Travel	Travel Range Options	Mounting Pattern Range
LFD1U	56 - 79 kg	400 mm	82.6 - 122.4 cm; 90.2 - 130 cm; 97.8 - 137.3 cm; 105.4 - 145.3 cm; 113 - 152.9 cm	200 x 200 - 800 x 400 mm
MFD1U	30 - 59 kg			



FUSION™ CART & STAND ACCESSORIES



FCA624*	Color	Compatibility
Dual Display Adapter Accessory	S B	XPA1U, XVAU

*XPA1U cart shown with FCA624 Dual display adapter.

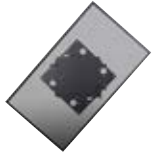

FRA	Dimensions	Compatibility
Freestyle Rotation Adapter	438 x 438 x 21 mm	LPAU, MPAU, LFAU, MFAU



FCA613	Dimensions (WxD)	Weight Capacity	Compatibility
Large, Height-Adjustable Accessory Shelf	1219 x 529 mm	11.3 kg	MPAU, MFAU, LPAU, LFAU, XPA1U



FCA611	Dimensions (WxD)	Weight Capacity	Compatibility
Small, Height-Adjustable Accessory Shelf	619 x 386 mm	11.3 kg	MPAU, MFAU, LPAU, LFAU



FCA650/651	Compatibility
Large & Medium CPU Holders	MPAU, MFAU, LPAU, LFAU
Model	Max Equipment Size (HxWxD)
FCA650	381 x 130 x 381 mm
FCA651	254 x 92 x 254 mm



FCA510/515	Compatibility
Storage Accessories	All Fusion Ceiling & Freestanding Mounts
Model	Dimensions (HxWxD)
FCA510	267 x 267 x 76 mm
FCA515	394 x 394 x 114 mm



FCA520	Max Equipment Depth	Compatibility
Universal Clamp Kit (Qty 2)	83 mm	All Fusion Ceiling & Freestanding Mounts



FCA800/FCA801	Compatibility	
Above/Below Shelf, Large* Displays	Fusion Fixed & Tilt Wall, Freestanding & Ceiling Mounts	
Model	Size	Weight Capacity
FCA800	203 mm	9.1 kg
FCA801	355 mm	9.1 kg

*Typical screen size: 46-70".



FCA810/FCA811	Compatibility	
Above/Below Shelf, XL* Displays	Fusion Fixed & Tilt Wall, Freestanding & Ceiling Mounts	
Model	Size	Weight Capacity
FCA810	203 mm	9.1 kg
FCA811	355 mm	9.1 kg

*Typical screen size: 70-100".



FCA820/FCA821	Compatibility	
Fusion Center Camera Shelf	Fusion Ceiling, Freestanding and Wall Mounts	
Model	Size	Weight Capacity
FCA820	203 mm	9.1 kg
FCA821	355 mm	9.1 kg



FCA802/FCA812	Compatibility	
Component Shelf, Large Displays	Fusion Fixed & Tilt Wall, Freestanding & Ceiling Mounts	
Model	Typical Screen Size	Weight Capacity
FCA802	46 - 70"	9.1 kg
FCA812	70 - 100"	9.1 kg

FUSION™ CART & STAND

ACCESSORIES



FCA830/FCA840		Compatibility
Center Channel Speaker Adapter		Fusion Fixed & Tilt Wall, Freestanding & Ceiling Mounts
Model	Typical Screen Size	Weight Capacity
FCA830	52 - 80"	9.1 kg
FCA840	70 - 100"+	9.1 kg



FCA831/FCA841		Compatibility
Center Channel Speaker Adapter		Fusion Fixed & Tilt Wall, Freestanding & Ceiling Mounts
Model	Typical Screen Size	Weight Capacity
FCA831	42 - 70"	4.5 kg/side
FCA841	50 - 95"	4.5 kg/side



FCACLIPS	Compatibility
Anchor Points for Zip Ties (Qty 10)	All Fusion Ceiling & Freestanding Mounts

OTHER CARTS & STANDS MOUNTS

XVM1U 65"+ XL CART



Robust solution designed to support heavy duty displays and XL interactive solutions, such as the Microsoft® Surface Hub™.

Weight Capacity	Dimensions (HxWxD)	Mounting Patterns (W,H)	Plumb Adjust	Color
140.6 kg	194 x 231.2 x 105.7 cm	1200, 1100, 1000, 900, 800, 700, 600, 500, 400 x 600 or 400 mm	1.6"	B



PFCU 42 - 60" HEIGHT-ADJUSTABLE CART



A collapsible mobile cart for portrait and landscape orientations - ideal for corporate and rental/staging applications.

Weight Capacity	Dimensions (HxWxD)	Mounting Patterns (W,H)	Center of Display to Floor range	Tilt	Color
90.7 kg	2073 x 943 x 816 mm	200 x 200 - 862 x 517 mm	1220 x 1830 mm	±15°	B



PF1U 42 - 60" HEIGHT-ADJUSTABLE STAND



A solid, low profile single display floor stand with integrated cable management and support for both portrait and landscape orientations.

Weight Capacity	Dimensions (HxWxD)	Mounting Patterns (W,H)	Center of Display to Floor Range	Tilt	Color
90.7 kg	2388 x 914 x 762 mm	200 x 200 - 862 x 517 mm	1300 - 2170 mm	±15°	B



MFCU 30 - 55" HEIGHT-ADJUSTABLE CART



Smaller version of the PFC with landscape and portrait orientation capability.

Weight Capacity	Dimensions (HxWxD)	Mounting Patterns (W,H)	Center of Display to Floor Range	Tilt	Color
56.7 kg	1975 x 943 x 816 mm	100 x 100 - 709 x 431 mm	1220 - 1830 mm	±15°	B



MF1U 30 - 55" HEIGHT-ADJUSTABLE STAND



A solid, low profile single display floor stand with integrated cable management. Supports portrait and landscape orientations.

Weight Capacity	Dimensions (HxWxD)	Mounting Patterns (W,H)	Center of Display to Floor Range	Tilt	Color
56.7 kg	2327 x 914 x 762 mm	100 x 100 - 709 x 431 mm	1300 - 2180 mm	±15°	B



MFAUBSP HEIGHT-ADJUSTABLE STRETCH PORTRAIT STAND



Rounded edges and sleek features give this stand a softer professional feel while supporting stretch displays in portrait configuration.

Weight Capacity	Dimensions (HxWxD)	Mounting Patterns (W,H)	Center of Display to Floor Range	Tilt	Color
56.7 kg	2038 x 967 x 771 mm	200 x 200, 200 x 400, 200 x 600, 200 x 800	1131 - 1639 mm	±5°	B



MPAUBSP HEIGHT-ADJUSTABLE STRETCH PORTRAIT CART





A solid, low profile single display floor stand with integrated cable management. Supports portrait and landscape orientations.

Weight Capacity	Dimensions (HxWxD)	Mounting Patterns (W,H)	Center of Display to Floor Range	Tilt	Color
56.7 kg	2170 x 1088 x 978 mm	200 x 200, 200 x 400, 200 x 600, 200 x 800	1270 - 1770 mm	±5°	B



PORTABLE FLAT PANEL STAND FEATURES

-  **HEAVY DUTY DESIGN**
Rugged design withstands the wear and tear that is commonplace with set up and tear down stands
-  **FAST INSTALLATION**
No tools needed for intuitive set up in under two minutes, even the first time.
-  **SPACE SAVINGS**
Breaks down and folds up for easy space savings when not in use.
-  **CABLE MANAGEMENT**
Tool-free cable management for a clean, professional look.

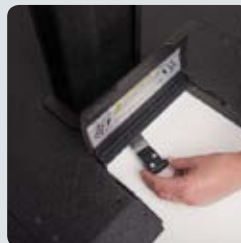

PRSU PORTABLE FLAT PANEL STAND



This easy-to-install stand is designed to handle the stress of building up and tearing down.

Weight Capacity	Dimensions (HxWxD)	Mounting Patterns (W,H)	Center of Display to Floor Range	Tilt	Color
90.7 kg	2034 x 913 x 851 mm	200 x 200, 860 x 515	1142 - 1828 mm	±15°	B



PORTABLE FLAT PANEL STAND ACCESSORIES



PAC900	Dimensions	Color
Portable Flat Panel Stand Case	354 x 1480 x 540 mm	B



PAC910	Weight Capacity	Dimensions	Color
Portable Flat Panel Stand Shelf	11.3 kg	82 x 457 x 308 mm	B

OTHER CARTS & STANDS ACCESSORIES



PAC722	Compatibility
P-Series Dual Side-by-Side Display Accessory	PFCU, PFIU



MAC722	Compatibility
M-Series Dual Side-by-Side Display Accessory	MFCU, MFIU



PAC715/716	Compatibility	
Video Conferencing Camera Shelves - Above or Below	P-Series (356 x 356 mm) & M-Series (200 x 200 mm) Q-Latch	
Model	Dimensions (WxD)	Weight Capacity
PAC715	229 x 223 mm	4.5 kg
PAC716	356 x 301 mm	4.5 kg



PAC710	Dimensions (WxD)	Weight Capacity	Compatibility
Height Adjustable Accessory Shelf	457 x 305 mm	11.3 kg	P- & M-Series Carts & Floor Stands



PAC730A	Max Equipment Size (HxWxD)	Compatibility
Secure Storage Shelf w/ Lock	89 x 445 x 305 mm	P- & M-Series Carts & Floor Stands



PAC400	Compatibility
P-Series Rotation Adapter	PFCU, PFIU & Other Q-Latch Mounts

PACTP1	Compatibility
Touch Panel Stabilizer Kit	P- & M-Series Carts & Floor Stands



KFA220B/S	Compatibility
Dual Monitor Accessory - Black / Silver	P- & M-Series Carts & Floor Stands



KFA225B/S	Compatibility
Widescreen Dual Monitor Accessory - Black / Silver	P- & M-Series Carts & Floor Stands



KFA320B/S	Compatibility
Triple Monitor Accessory - Black / Silver	P- & M-Series Carts & Floor Stands



KFA325B/S	Compatibility
Widescreen Triple Monitor Accessory - Black / Silver	P- & M-Series Carts & Floor Stands

TABLE STAND DISPLAY MOUNTS

STLU 32 - 52" TABLE STAND



This bolt-down swivel table stand ships with security hardware - ideal for hospitality installs.

Weight Capacity	Dimensions (HxWxD)	Mounting Patterns (W,H)	Swivel Options
56.7 kg	603 x 698 x 140 mm	100 x 100 - 600 x 400 mm	15°, 30°, 45° or 90°



PTSU 30-50" TABLE STAND



Stylish solutions for residential, commercial and business applications.

Weight Capacity	Dimensions (HxWxD)	Mounting Patterns (W,H)	Height Adjust
45.4 kg	545 x 607 x 278 mm	200 x 200 - 860 x 515 mm	102 mm



STS1 18 - 32" BOLT-DOWN TABLE STAND



This secure, bolt-down table stand for small screens provides swivel and tilt capability - ideal for point of sale applications.

Weight Capacity	Dimensions (HxWxD)	Mounting Patterns (W,H)	Height Adjust	Pivot/Tilt	Swivel Range Options
13.6 kg	409 x 152 x 175 mm	75 x 75 - 100 x 100 mm	130 mm	±15°	90°, 180°, 270°





DESK MONITOR MOUNTS

(Shown with Apple Cinema Display adapter, not included.)

KONTOUR™ K1 DYNAMIC HEIGHT-ADJUST DESK MOUNTS FEATURES



HEAVY DUTY DESIGN
Features sleek, solidly constructed forged aluminum arms.



ULTIMATE FLEXIBILITY
Gas-spring technology provides 330mm of smooth dynamic height adjustment and enables ideal positioning.



CABLE MANAGEMENT
Tool-free cable management covers create a clean, professional look.



FAST INSTALLATION
Simple 3-step installation and integrated quick-connect monitor interface makes mounting and maintenance easy.



CENTRIS® EXTREME TILT
Tilts -75°/+10° for the ultimate ergonomic solution.



MOUNTING PATTERN
Compatible with 75 x 75 mm and 100 x 100 mm VESA® patterns.

K1C220 DUAL MONITOR COLUMN CLAMP



This dynamic mount provides extended reach for 2 monitors. Offers independent manual height adjust on the column up to 178 mm and 330mm of dynamic height adjustment. For reduced height: K1C220_XRH.

Minimum Depth from Back of Desk	Maximum Extension	Weight Capacity (per monitor)	Colors
62 mm	523 mm	2.3 - 11.3 kg	W B



K1C210 DUAL MONITOR COLUMN CLAMP



Provides a low-profile solution for 2 monitors installed next to a cubical wall or adjacent desk, with 178 mm independent manual height adjust and 330mm of dynamic height adjustment. Features single-link arms.

Minimum Depth from Back of Desk	Maximum Extension	Weight Capacity (per monitor)	Colors
62 mm	352 mm	2.3 - 11.3 kg	S B



K1C22H DUAL MONITOR COLUMN CLAMP ARRAY



Securely holds 2 monitors on an array bar. Offers manual height adjust on the column up to 178 mm and 330mm of dynamic height adjustment with dual-link arm. For reduced height: K1C22H_XRH.

Minimum Depth from Back of Desk	Maximum Extension	Weight Capacity (per monitor)	Max Display Width	Colors
156 mm	587 mm	0.9 - 4.08 kg	632 mm	B



K1C120 SINGLE MONITOR COLUMN CLAMP



Dynamic dual-link mount provides extended reach for a single monitor. Offers 178mm of manual height adjustment on the column and 330mm of dynamic height adjustment. For reduced height: K1C120_XRH.

Minimum Depth from Back of Desk	Maximum Extension	Weight Capacity	Colors
62 mm	571 mm	2.3 - 11.3 kg	W B



K1C330 TRIPLE MONITOR DYNAMIC COLUMN MOUNT



Flexible ergonomic support for 3 monitors, or 2 monitors plus laptop using the KRA300 laptop tray accessory. Offers 178mm of manual height adjustment on the column, and 330mm of dynamic height adjustment.



Minimum Depth from Back of Desk	Maximum Extension	Weight Capacity	Colors
62 mm	648 mm	2.3 - 9.07 kg	B W

K1C420 QUAD (2X2) MONITOR DYNAMIC COLUMN MOUNT



Flexible ergonomic support for 4 monitors, featuring 330mm of dynamic height adjustment range plus additional manual adjustment on the column.



Minimum Depth from Back of Desk	Maximum Extension	Weight Capacity (per monitor)	Colors
62 mm	648 mm	2.3 - 9.07 kg	B W

K1C110 SINGLE MONITOR COLUMN CLAMP



Dynamic single-link mount is best suited for applications requiring minimal extension range. Offers manual height adjustment on the column up to 178 mm and dynamic height adjustment up to 330 mm.



Minimum Depth from Back of Desk	Maximum Extension	Weight Capacity	Colors
62 mm	400 mm	2.3 - 11.3 kg	S B

K1D220 DUAL MONITOR DESK CLAMP



Featuring dual-link arms, this dynamic mount securely holds 2 monitors and provides 330 mm of dynamic height adjustment. For reduced height: K1D220_XRH.



Minimum Depth from Back of Desk	Maximum Extension	Weight Capacity (per monitor)	Colors
62 mm	548 mm	2.3 - 11.3 kg	B W

K1D22H DUAL MONITOR DESK ARRAY



Securely holds 2 monitors on an array bar allowing for perfect alignment and low-profile placement. Flexible dual-link arm offers dynamic height adjustment up to 330 mm. For reduced height: K1D22H_XRH.

Minimum Depth from Back of Desk	Maximum Extension	Weight Capacity (per monitor)	Max Display Width	Colors
109 mm	538 mm	0.9 - 4.08 kg	632 mm	B



K1D120 SINGLE MONITOR DESK CLAMP



Dynamic dual-link mount securely holds a single monitor and provides up to 330 mm of dynamic height adjustment. For reduced height: K1D120_XRH.

Minimum Depth from Back of Desk	Maximum Extension	Weight Capacity	Colors
62 mm	523 mm	2.3 - 11.3 kg	B W S



KONTOUR™ K1 DYNAMIC HEIGHT-ADJUST DESK MOUNTS

ACCESSORIES



KRA220	Compatibility
Extension Arm Accessory	K1 and K2 Series Mounts*



KRA223	Compatibility
Dual Monitor Array Bar	K1 and K2 Series Mounts*



KRA224	Compatibility
Dual Monitor Array Bar Handle	KRA223



KSA1250B	Compatibility
Quick-Connect Interface for Dell UltraSharp Monitors	All Kontour products



KRA300	Compatibility
Laptop Accessory	K1 & K2 Series Mounts

FSB4073	Compatibility
50 x 50 mm VESA® Adapter Bracket	Mounts with 100 x 100 mm VESA® patterns & displays with 50 x 50 mm VESA patterns

FSB4041	Compatibility
200 x 200 mm VESA® Adapter Bracket	Mounts with 100 x 100 mm VESA pattern & displays using M8 screws with 200 x 200 mm VESA patterns

KONTOUR™ K2 DESK MOUNT FEATURES



HEAVY DUTY DESIGN
Features sleek, solidly constructed forged aluminum arms.



ULTIMATE FLEXIBILITY
Column mount slides vertically along column for ideal positioning and provides 273 mm of manual height adjustment.



FAST INSTALLATION
Tear-drop hole pattern for easy mounting and maintenance.



CABLE MANAGEMENT
Tool-free cable management guide clips for a clean, professional look.



CENTRIS™ TILT
Tilts ±15° for a flexible, ergonomic solution.



MOUNTING PATTERN
Compatible with 75 x 75 mm and 100 x 100 mm VESA® patterns.

K2C220 DUAL MONITOR COLUMN CLAMP



Dual monitor column clamp mounts easily to edge of desk or through typical grommet hole. Features flexible dual-link articulating arms with independent manual height adjustment.

Minimum Depth from Back of Desk	Maximum Extension	Max Weight Capacity (per monitor)	Colors
105 mm	448 mm	11.3 kg	S B



K2C22H DUAL MONITOR COLUMN ARRAY



Securely holds 2 monitors on an array bar allowing for perfect alignment and low-profile placement. Flexible, dual-link arm offers manual height adjustment.

Minimum Depth from Back of Desk	Maximum Extension	Weight Capacity (per monitor)	Maximum Display Width	Colors
156 mm	499 mm	4.08 kg	632 mm	B



K2C120 SINGLE MONITOR COLUMN CLAMP



Single monitor column clamp mounts easily to the edge of desk or through typical grommet hole. Features flexible dual-link arm with manual height adjustment.

Minimum Depth from Back of Desk	Maximum Extension	Weight Capacity	Colors
152 mm	495 mm	18.1 kg	S B



K2C110 SINGLE MONITOR COLUMN CLAMP



Single monitor column clamp mounts easily to the edge of desk or through typical grommet hole. Features single-link arm with manual height adjustment.

Minimum Depth from Back of Desk	Maximum Extension	Weight Capacity	Colors
152 mm	324 mm	18.1 kg	S B



KONTOUR™ K2 SERIES DESK MOUNT ACCESSORIES



KRA219	Compatibility
Table Clamp Mount Kit	K1 and K2 Series Mounts*



KRA220	Compatibility
Extension Arm Accessory	K1 and K2 Series Mounts*



KRA222	Compatibility
Expansion Arm Kit	K2C Series Mounts*



KRA223	Compatibility
Dual Monitor Array Bar	K1 and K2 Series Mounts*



KRA224	Compatibility
Dual Monitor Array Bar Handle	KRA223



KSA1250B	Compatibility
Quick-Connect Interface for Dell UltraSharp Monitors	All Kontour products

FSB4041	Compatibility
200 x 200 mm VESA® Adapter Bracket	Mounts with 100 x 100 mm VESA pattern & displays using M8 screws with 200 x 200 mm VESA patterns



KRA300	Compatibility
Laptop tray accessory	K1 and K2 Series Mounts*



DESK ARRAY MONITOR MOUNTS

KONTOUR™ K3 STATIC DESK ARRAYS FEATURES



LATERAL SHIFT

Centris heads are easily moved along array arms for quick lateral shift adjustments.



ULTIMATE FLEXIBILITY

Independently height adjustable arms (and center head where applicable) provide seamless screen alignment. Arms can be adjusted from 0° to 15° for customized viewing angles.



HEAVY DUTY DESIGN

Features sleek, solidly constructed arms with that hold 6.8 kg per monitor.



CENTRIS™ TILT

Offers up to ±12° of Centris fingertip tilt for effortless display positioning.



MODULARITY

Meets a wide range of monitor sizes and configurations. A great multi monitor array solution for call centers, security desks, IT, health care, control rooms and other multi-monitor settings.



MOUNTING PATTERN

Compatible with 75 x 75 mm and 100 x 100 mm VESA® patterns.

K3F220B FREESTANDING 2x2 ARRAY



Static freestanding array mount for monitors 2 wide x 2 tall.

Maximum Monitor Height	Maximum Monitor Width	Tilt	Typical Screen Size	Weight Capacity (per monitor)	Colors
460 mm	736 mm	±12°	10 - 27"	6.8 kg	B



K3G220B GROMMET MOUNTED 2x2 ARRAY



Static grommet array mount for monitors 2 wide x 2 tall. Compatible with desks 13 - 127 mm thick.

Maximum Monitor Height	Max Monitor Width	Tilt	Typical Screen Size	Weight Capacity (per monitor)	Colors
460 mm	736 mm	±12°	10 - 27"	6.8 kg	B



K3G320B GROMMET MOUNTED 3x2 ARRAY



Static grommet array mounts for 3 wide x 2 tall multi-monitor array. Compatible with desks 13 - 127 mm thick.

Max Monitor Width	Tilt	Typical Screen Size	Weight Capacity (per monitor)	Colors
Dual display - 1301 mm Triple display - 650 mm	Outer - ±12° Center - ±10°	Dual: up to 30" Triple: up to 27"	6.8 kg	B

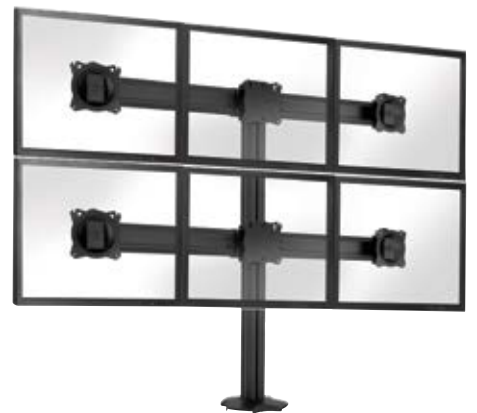

K3F310B FREESTANDING 3x1/2x1 ARRAY



Static freestanding array mount for 2 or 3 monitor/tablet combinations. Telescoping rails add 203 mm per arm of additional lateral adjustment.

Maximum Monitor Width	Tilt	Typical Screen Size	Weight Capacity (per monitor)	Colors
Dual display - 1301 mm Triple display - 650 mm	Outer - $\pm 12^\circ$ Center - $\pm 10^\circ$	Dual: up to 30" Triple: up to 27"	6.8 kg	B



K3G310B GROMMET MOUNTED 3x1/2x1 ARRAY



Static grommet array mount for 2 or 3 monitor arrays. Telescoping rails add 203 mm per arm of additional lateral adjustment.

Monitor Width Range	Tilt	Typical Screen Size	Desktop Thickness	Weight Capacity (per monitor)	Colors
Dual display - 1301 mm Triple display - 650 mm	Outer - 12° Center - 10°	Dual: up to 30" Triple: up to 27"	13 - 127 mm	6.8 kg	B



K3F120B FREESTANDING 1x2 ARRAY



Static freestanding array mount for 2 monitors arranged vertically.

Maximum Monitor Height	Tilt	Typical Screen Size	Weight Capacity (per monitor)	Colors
460 mm	$\pm 10^\circ$	10 - 30"	6.8 kg	B



K3G120B GROMMET MOUNTED 1x2 ARRAY



Static grommet array mount for 2 monitors arranged vertically. Compatible with desks 13 - 127 mm thick.

Maximum Monitor Height	Tilt	Typical Screen Size	Weight Capacity (per monitor)	Colors
460 mm	$\pm 10^\circ$	10 - 30"	6.8 kg	B

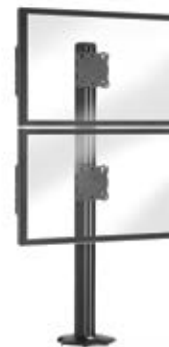

KONTOUR™ K3 SERIES DESK ARRAY ACCESSORIES



KRA500	Compatibility
Desk Clamp Accessory	K3 Series Mounts



KSA1250	Compatibility
Quick-Connect Interface for Dell UltraSharp Monitors	All Kontour products



KRA300	Compatibility
Laptop Accessory	K1 & K2 Series Mounts

FSB4073	Compatibility
50 x 50 mm VESA® Adapter Bracket	Mounts with 100 x 100 mm VESA® patterns & displays with 50 x 50 mm VESA patterns

FSB4041	Compatibility
200 x 200 mm VESA® Adapter Bracket	Mounts with 100 x 100 mm VESA pattern & displays using M8 screws with 200 x 200 mm VESA patterns

KONTOUR™ K4 DEPTH-ADJUSTABLE DESK ARRAYS

FEATURES



FOCAL DEPTH ADJUSTMENT
Provides articulating focal depth adjustment for optimal ergonomics in multi-user environments, allowing you to reposition the bank of screens to a preferred viewing distance.



AESTHETIC DESIGN
Form meets function with the K4 Series. Solidly constructed, forged aluminum arms are sleekly designed for a clean appearance.



EXCEPTIONAL FLEXIBILITY
Swivel and pan adjustment capability and Centris® Fingertip Tilt for ideal screen positioning. Also includes an integrated handle for quick ergonomic adjustment to fit the user.



MOUNTING PATTERN
Compatible with 75 x 75 mm and 100 x 100 mm VESA® patterns.



CENTRIS® TILT
Offers up to ±12° of Centris™ fingertip tilt for effortless display positioning.

K4G610B GROMMET MOUNTED 6x1 ARRAY



Focal depth adjustable grommet array mount for 6 monitors in a row with two anchor points. Extends up to 412 mm and offers ±12° tilt.



Center of Display to Table Range	Max Width (per monitor)	Minimum Depth	Typical Screen Size	Weight Cap. (per monitor)	Desktop Thickness
291 - 463 mm	614 mm	815 mm	up to 24"	6.8 kg	25 - 125 mm

K4G510B GROMMET MOUNTED 5x1 ARRAY



Focal depth adjustable grommet array mount for 5 monitors in a row with two anchor points. Extends up to 412 mm and offers ±12° of monitor tilt.



Center of Display to Table Range	Max Width (per monitor)	Minimum Depth	Typical Screen Size	Weight Cap. (per monitor)	Desktop Thickness
291 - 463 mm	614 mm	592 mm	up to 24"	6.8 kg	25 - 125 mm



K4G410B GROMMET MOUNTED 4x1 ARRAY



Focal depth adjustable grommet array mount for 4 monitors in a row with two anchor points. Extends up to 412 mm and offers $\pm 12^\circ$ of monitor tilt.

Center of Display to Table Range	Max Width (per monitor)	Minimum Depth	Typical Screen Size	Weight Cap. (per monitor)	Desktop Thickness
291 - 463 mm	614 mm	396 mm	up to 24"	6.8 kg	25 - 125 mm



K4G310B GROMMET MOUNTED 3x1 ARRAY



Focal depth adjustable grommet array mount for 3 monitors in a row with one anchor point. Extends up to 412 mm and offers $\pm 12^\circ$ of monitor tilt and 20° arm angle.

Center of Display to Table Range	Max Width (per monitor)	Minimum Depth	Typical Screen Size	Weight Cap. (per monitor)	Desktop Thickness
291 - 463 mm	614 mm	239 mm	up to 24"	6.8 kg	25 - 125 mm



K4G210B GROMMET MOUNTED 2x1 ARRAY



Focal depth adjustable grommet array mount for 2 monitors in a row with one anchor point. Extends up to 412 mm and offers $\pm 12^\circ$ of monitor tilt and 20° arm angle.

Center of Display to Table Range	Max Width (per monitor)	Minimum Depth	Typical Screen Size	Weight Cap. (per monitor)	Desktop Thickness
291 - 463 mm	943 mm	239 mm	up to 24"	6.8 kg	25 - 125 mm



K4G120B GROMMET MOUNTED 1x2 ARRAY



Focal depth adjustable grommet array mount for 2 monitors stacked with one anchor point. Offers $\pm 10^\circ$ of monitor tilt.

Center of Display to Table Range	Max. Monitor Height	Minimum Depth	Typical Screen Size	Weight Cap. (per monitor)	Desktop Thickness
291 - 463 mm	406 mm	239 mm	up to 24"	6.8 kg	25 - 125 mm



K4G620B GROMMET MOUNTED 6X2 ARRAY



Focal depth adjustable grommet array mount for 12 monitors stacked with two anchor points. Extends at least 305 mm and offers $\pm 12^\circ$ tilt.

Center of Display to Table Range	Max. Monitor Height	Minimum Depth	Typical Screen Size	Weight Cap. (per monitor)	Desktop Thickness
269 - 1107 mm	584 mm	815 mm	up to 24"	6.8 kg	25 - 125 mm

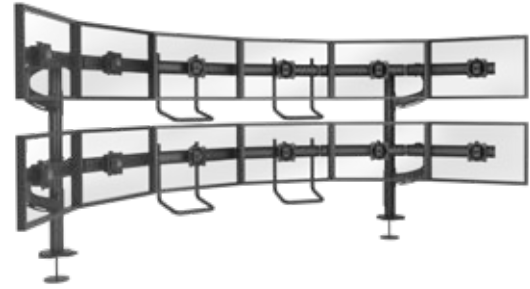

K4G520B GROMMET MOUNTED 5X2 ARRAY



Focal depth adjustable grommet array mount for 10 monitors in two rows with two anchor points. Extends at least 305 mm and offers $\pm 12^\circ$ tilt.

Center of Display to Table Range	Max Width (per monitor)	Minimum Depth	Typical Screen Size	Weight Cap. (per monitor)	Desktop Thickness
269 - 1107 mm	584 mm	592 mm	up to 24"	6.8 kg	25 - 125 mm

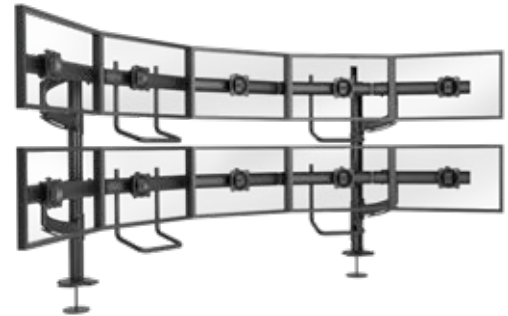

K4G420B GROMMET MOUNTED 4X2 ARRAY



Focal depth adjustable grommet array mount for 8 monitors in two rows with two anchor points. Extends at least 305 mm and offers $\pm 12^\circ$ tilt.

Center of Display to Table Range	Max Width (per monitor)	Minimum Depth	Typical Screen Size	Weight Cap. (per monitor)	Desktop Thickness
269 - 1107 mm	584 mm	396 mm	up to 24"	6.8 kg	25 - 125 mm

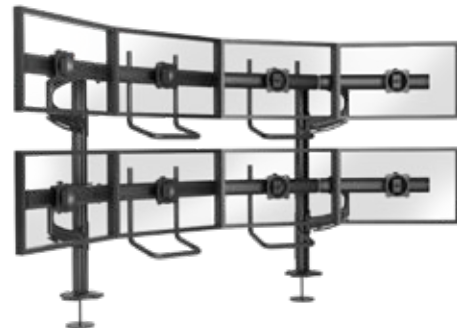

K4G320B GROMMET MOUNTED 3x2 ARRAY



Focal depth adjustable grommet array mount for 6 monitors in two rows with one anchor point. Extends at least 305 mm and offers $\pm 12^\circ$ tilt.

Center of Display to Table Range	Max Width (per monitor)	Minimum Depth	Typical Screen Size	Weight Cap. (per monitor)	Desktop Thickness
269 - 1107 mm	584 mm	318 mm	up to 24"	6.8 kg	25 - 125 mm

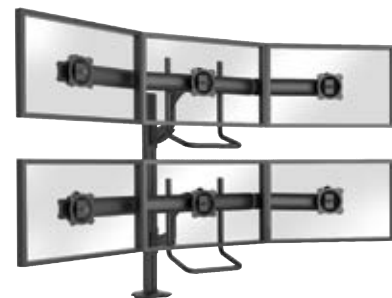

KONTOUR™ K4 SERIES DESK ARRAY ACCESSORIES



KSA1250	Compatibility
Quick-Connect Interface for Dell UltraSharp Monitors	All Kontour products



KRA300	Compatibility
Laptop Accessory	K1 & K2 Series Mounts

FSB4073	Compatibility
50 x 50 mm VESA® Adapter Bracket	Mounts with 100 x 100 mm VESA® patterns & displays with 50 x 50 mm VESA patterns

FSB4041	Compatibility
200 x 200 mm VESA® Adapter Bracket	Mounts with 100 x 100 mm VESA pattern & displays using M8 screws with 200 x 200 mm VESA patterns



WALL MONITOR MOUNTS

KONTOUR™ K1 SERIES WALL MOUNT FEATURES



HEAVY DUTY DESIGN
Features sleek and solid forged aluminum arms.



ULTIMATE FLEXIBILITY
Gas-spring technology provides smooth dynamic height adjustment up to 330 mm and enables ideal monitor positioning.



FAST INSTALLATION
Simple 3-step installation and integrated quick-connect interface for easy mounting and maintenance.



CABLE MANAGEMENT
Tool-free cable management covers create a clean, professional look.



CENTRIS® EXTREME TILT
Tilts -75°/+10° for an ultimate ergonomic solution.



MOUNTING PATTERN
Compatible with 75 x 75 mm and 100 x 100 mm VESA patterns.

K1W220 DUAL MONITOR WALL MOUNT



Featuring flexible dual-link arms, this mount provides 330mm of dynamic height adjustment for 2 monitors.

Minimum Depth from Wall	Maximum Extension	Weight Capacity (per monitor)	Colors
62 mm	525 mm	2.3 - 11.3 kg	B



K1W120 SINGLE MONITOR WALL MOUNT



Featuring flexible dual-link arm, this mount provides 330mm of dynamic height adjustment of the monitor.

Minimum Depth from Wall	Maximum Extension	Weight Capacity	Colors
62 mm	512 mm	2.3 - 11.3 kg	B W



K1W110 SINGLE MONITOR WALL MOUNT



With a short single-link arm, this mount provides 330mm of dynamic height adjustment of the monitor.

Minimum Depth from Wall	Maximum Extension	Weight Capacity	Colors
62 mm	341 mm	2.3 - 11.3 kg	B



KONTOUR K1 SERIES WALL MOUNT

ACCESSORIES



KRA219	Compatibility
Table Clamp Mount Kit	K1 and K2 Series Mounts*



KRA220	Compatibility
Extension Arm Accessory	K1 and K2 Series Mounts*



KRA223	Compatibility
Dual Monitor Array Bar	K1 and K2 Series Mounts*



KRA300	Compatibility
Laptop Accessory	K1 & K2 Series Mounts



KRA224	Compatibility
Dual Monitor Array Bar Handle	K1 and K2 Series Mounts*

FSB4073	Compatibility
50 x 50 mm VESA® Adapter Bracket	Mounts with 100 x 100 mm VESA® patterns & displays with 50 x 50 mm VESA patterns

FSB4041	Compatibility
200 x 200 mm VESA® Adapter Bracket	Mounts with 100 x 100 mm VESA pattern & displays using M8 screws with 200 x 200 mm VESA patterns

KONTOUR™ K2 SERIES WALL MOUNT FEATURES



HEAVY DUTY DESIGN
Features sleek, solidly constructed forged aluminum arms.



FAST INSTALLATION
Tear-drop hole pattern for easy mounting and maintenance.



CENTRIS™ TILT
Tilts $\pm 15^\circ$ for a flexible ergonomic solution.



CABLE MANAGEMENT
Tool-free cable management guide clips for a clean, professional look.



MOUNTING PATTERN
Compatible with 75 x 75 mm and 100 x 100 mm VESA® patterns.



CENTRIS™ TILT

K2W120 SINGLE MONITOR WALL MOUNT



Securely attaches a single monitor to the wall. Features a dual-link arm for added flexibility.

Minimum Depth from Back of Wall	Maximum Extension	Weight Capacity	Colors
75 mm	437 mm	18.1 kg	S B



KONTOUR™ K2 SERIES WALL MOUNT ACCESSORIES

FSB4073	Compatibility
50 x 50 mm VESA® Interface Bracket	Mounts with 50 x 50 mm VESA pattern & displays using M8 screws with 200 x 200 mm VESA patterns

FSB4041	Compatibility
200 x 200 mm VESA® Adapter Bracket	Mounts with 100 x 100 mm VESA pattern & displays using M8 screws with 200 x 200 mm VESA patterns



KRA300	Compatibility
Laptop Accessory	K1 & K2 Series Mounts

OTHER KONTOUR™ WALL MOUNTS

KOW100 PITCH/PIVOT SINGLE WALL MOUNT



Easily attaches a monitor to the wall and provides smooth pivot and tilt adjustment for optimal viewing.

Weight Capacity	Mounting Patterns (W,H)	Tilt	Minimum Depth from Wall	Typical Screen Size	Colors
18.1 kg	75 x 75 mm, 100 x 100 mm	+75°, -10°	81 mm	10 - 32"	S B



KONTOUR™ K4 SERIES DEPTH-ADJUSTABLE WALL MOUNTS

FEATURES



FOCAL DEPTH ADJUSTMENT

An easily adjustable solution for monitor array workstations where multiple users need to reposition the bank of screens to their preferred viewing distance. Perfect for control rooms, trading desks, call centers, security desks, IT, healthcare and more.



EXCEPTIONAL FLEXIBILITY

Provides articulating focal depth adjustment, swivel and pan adjustment capability and Centris® Fingertip Tilt for ideal screen positioning. Also includes an integrated handle for quick ergonomic adjustment to fit the user.



AESTHETIC DESIGN

Form meets function with the K4 Series. Solidly constructed, forged aluminum arms are sleekly designed for a clean appearance.



MOUNTING PATTERN

Compatible with 75 x 75 mm and 100 x 100 mm VESA® patterns.

K4W310B WALL MOUNTED 3x1 ARRAY



Adjustable wall mount for 3 monitors in a row with one anchor point.

Max. Monitor Width	Extension	Minimum Depth	Arm Rotation	Typical Screen Size	Tilt	Weight Capacity (per monitor)
614 mm	412 mm	239 mm	0 - 20°	up to 24"	±12°	6.8 kg



K4W210B WALL MOUNTED 2x1 ARRAY



Adjustable wall mount for 2 monitors in a row with one anchor point.

Max. Monitor Width	Extension	Minimum Depth	Arm Rotation	Typical Screen Size	Tilt	Weight Capacity (per monitor)
943 mm	412 mm	239 mm	0 - 20°	up to 30"	±12°	6.8 kg



K4W120B WALL MOUNTED 1x2 ARRAY



Adjustable wall mount for 2 monitors arranged vertically with one anchor point.

Max. Monitor Height	Extension	Minimum Depth	Tilt	Weight Capacity (per monitor)
406 mm	412 mm	94 mm	±10°	6.8 kg



KONTOUR™ K1 SERIES POLE MOUNT FEATURES



EASY INSTALLATION

Simple 3-step installation and integrated quick-connect interface makes mounting and maintenance easy. Mounts on pre-existing poles with 38 - 48 mm outer diameters.



CENTRIS® EXTREME TILT

Centris® technology provides effortless tilt up to -75/+10°.



MOUNTING PATTERN

Compatible with 75 x 75 mm and 100 x 100 mm VESA® patterns.



HEAVY DUTY DESIGN

Features sleek and solid forged aluminum arms.



ULTIMATE FLEXIBILITY

Gas-spring technology provides smooth dynamic height adjustment up to 330 mm and enables ideal monitor positioning.



CABLE MANAGEMENT

Tool-free cable management covers create a clean, professional look.

K1P220 DUAL MONITOR POLE MOUNT



Dynamic pole mount firmly holds 2 monitors. Flexible dual-link arms provide up to 330 mm of height adjustment.

Column Diameter Range	Minimum Depth from Pole	Extension	Weight Capacity (per monitor)	Colors
38 - 48 mm	62 mm	510 mm	2.3 - 11.3 kg	B



K1P120 SINGLE MONITOR POLE MOUNT



Flexible dual-link arm provides up to 330 mm of height adjustment.

Column Diameter Range	Minimum Depth from Pole	Extension	Weight Capacity	Colors
38 - 48 mm	64 mm	493 mm	2.3 - 11.3 kg	S B



KONTOUR™ K1 SERIES POLE MOUNT ACCESSORIES

FSB4073	Compatibility
50 x 50 mm VESA® Adapter Bracket	Mounts with 100 x 100 mm VESA® patterns & displays with 50 x 50 mm VESA patterns

FSB4041	Compatibility
100 x 100 mm VESA® Adapter Bracket	Mounts with 100 x 100 mm VESA pattern & displays using M8 screws with 200 x 200 mm VESA patterns

KONTOUR™ K2 SERIES POLE MOUNT FEATURES



HEAVY DUTY DESIGN
Features sleek, solidly constructed forged aluminum arms.



CENTRIS™ TILT
Centris™ technology provides effortless tilt up to $\pm 15^\circ$.



CABLE MANAGEMENT
Includes tool-free cable management loops for a clean, professional look.



EASY INSTALLATION
Teardrop hole pattern makes mounting the screens quick and easy. Mounts on pre-existing poles with 38 - 48 mm outer diameters.



MOUNTING PATTERN
Compatible with 75 x 75 mm and 100 x 100 mm VESA® patterns.

K2P120 SINGLE MONITOR POLE MOUNT



Pole mount firmly holds a single monitor. Dual-link arm offers added flexibility.

Column Diameter Range	Minimum Depth from Pole	Maximum Extension	Weight Capacity	Colors
38 - 48 mm	74 mm	422 mm	18.1 kg	B



OTHER KONTOUR™ POLE MOUNT

KOP100 SINGLE MONITOR POLE MOUNT



Easily attaches a monitor to a pole and provides smooth pivot and tilt adjustment.

Column Diameter Range	Weight Capacity	Mounting Patterns (W,H)	Tilt	Min.Depth from Pole	Typical Screen Size	Colors
38 - 48 mm	18.1 kg	75 x 75 mm, 100 x 100 mm	+75°, -10°	66 mm	10 - 32"	S B



AV STORAGE ACCESSORIES



CSPH	Dimensions	Weight Capacity
Under Table Component Storage Panel	693 x 366 x 29 mm	9 kg



CSPR	Dimensions	Weight Capacity	Compatibility
On-Wall Component Storage Panel	615 x 264 x 29 mm	9 kg	Medium to Extra-Large Wall Mounts



INDEX

2018 EMEA CATALOG

C

CMA110 25, 26
 CMA274 75
 CMA275 75
 CMA330 25
 CMA340 75
 CMA345 25
 CMA347 25
 CMA351 25
 CMA395 25
 CMA640 25
 CMA643 25
 CMS003 26
 CMS006 26
 CMS009 26
 CMS012 26
 CMS018 26
 CMS024 26
 CMS036 26
 CMS048 26
 CMS060 26
 CMS072 26
 CMS115 25
 CMS0203 26
 CMS0305 26
 CMS0406 26
 CMS440 25
 CMS491 27
 CMS491C 27
 CMS492 27
 CMS492C 27
 CMS0507 26
 CMS006009 26
 CMS009012 26
 CMS012018 26
 CMS018024 26
 CMS Adjustable Columns 26
 CMS Fixed Columns 26
 CMSZ006 25
 CPA116 75
 CPA262 75
 CPA263 75
 CPA264 75
 CPA330 75
 CPA351 75, 78, 80
 CPA353 75, 78, 80
 CPA380 75

CPA395 75
 CPA Columns 75
 CPAE030 75
 CPAE080 75
 CPAE100 75
 CPAE150 75
 CPAE300 75
 CSPH 62
 CSPR 62

F

FCA2X1U 87
 FCA3U 76
 FCA3X1U 87
 FCA4U 76
 FCA102 44
 FCA103 37
 FCA106 37, 45, 44, 37, 51, 55, 61
 FCA510 76, 87, 92
 FCA510/515 87
 FCA515 76, 87, 92
 FCA520 76, 87, 92
 FCA535 87
 FCA611 92
 FCA612 92
 FCA623 92
 FCA650 92
 FCA651 92
 FCA776 88
 FCA800 37, 44, 45, 76, 87, 92
 FCA801 37, 44, 45, 76, 87, 92
 FCA802 76, 87, 92
 FCA810 37, 44, 76, 87, 92
 FCA811 37, 44, 76, 87, 92
 FCA812 76, 87, 92
 FCA820 37, 76, 87, 92
 FCA821 37, 44, 76, 87, 92
 FCA830 37, 44, 77, 88, 93
 FCA831 37, 44, 77, 88, 93
 FCA840 37, 44, 77, 88, 93
 FCA841 37, 38, 44, 77, 88, 93
 FCABX18 87
 FCABX36 87
 FCAC 76
 FCACLIPS 77, 88, 93
 FCASFP 52
 FCAVIU 37
 FCAX08 , 76, 51
 FCAX08/14/20 76
 FCAX14 , 76, 51
 FCAX20 , 76, 51, 87
 FCK000 37, 44
 FCK008 37, 44
 FCK016 37, 44
 FMSCA 52
 FMSCM 52
 FMSECAP 52
 FMSH48 52
 FMSH60 52
 FMSH72 52
 FMSH84 52
 FMSH96 52
 FMSH108 52
 FMSH120 52
 FMSHCO 52
 FMSHCI 52
 FMSIML 52
 FMSITL 52
 FMSSWA 52
 FMSSWM 52
 FRA 92
 FSB4041 103, 106, 110, 117, 118, 121
 FSB4073 103, 110, 117, 121
 FSRV 39
 FTRV 47

H

HC1 25, 26

I

IR10 29

J

JPPU 79

K

KOP100 122
 KOP100B 79
 KOW100 119
 KIC22H 100
 KIC110 101
 KIC120 100
 KIC210 100
 KIC220 100
 KIC330 101
 KIC420 101

K1D22H 102
 K1D120 102
 K1D220 101
 K1D230 101
 K1P120 121
 K1P220 121
 K1W120 116
 K1W220 116
 K2C22H 104, 105
 K2C120 105
 K2C220 104
 K2P120 122
 K2W120 118
 K3F120B 109
 K3F220B 108
 K3F310B 109
 K3G120B 109
 K3G220B 108
 K3G310B 109
 K3G320B 108
 K4G120B 112
 K4G210B 112
 K4G310B 112
 K4G320B 113
 K4G410B 112
 K4G420B 113
 K4G510B 111
 K4G520B 113
 K4G610B 111
 K4G620B 113
 K4W120B 120
 K4W210B 120
 K4W310B 120
 KFA220 97
 KFA225 97
 KFA320 97
 KFA325 97
 KITEC030045 19, 20
 KITEC045080 19, 20
 KITEC080135 19, 20
 KITMZ006S 6, 23
 KRA219 106, 117
 KRA220 103, 106, 117
 KRA221 106
 KRA223 103, 106, 117
 KRA224 , 51, 103
 KRA300 103
 KRA500 110

KSA1250 110, 114, 117, 118
 KSA1250B 103, 106

L

LBM1x2U 85
 LBM1x2UP 85
 LBM1x3U 84
 LBM2x2U 84, 85
 LBM2x2UP 85
 LBM3x1UP 83, 84, 86
 LBM3x2U 83
 LBM3x2UP 83
 LBM3x3U 82
 LC1 25, 26
 LCB1U 67
 LCB1x2U 68
 LCB2x1U 73
 LCB2x1UP 74
 LCB3x1U 74
 LCB3x1UP 74
 LCD2C 25, 26
 LCD2TS 25, 26
 LCDCP 25, 26
 LCDPA 25, 26
 LCM1U 65
 LCM1UP 66
 LCM1x2U 68
 LCM2x1U 72
 LCM2x1UP 72
 LCM2x2U 70
 LCM2x2UP 70
 LCM3U 69
 LCM3x1U 73
 LCM3x1UP 73
 LCM3x2U 71
 LCM3x2UP 71
 LCM3x3U 71
 LCM4U 69
 LFAU 90
 LFD1U 91
 LPAU 90
 LPD1U 91
 LSA1U 34
 LSD1U 36
 LSM1U 34
 LSTU 38, 39
 LTA1U 41
 LTM1U 41

LTTU 46
 LVM2x2U 84, 85
 LVM2x2UP 84, 85
 LVM3x1UP 83
 LVM3x2U 82
 LVM3x2UP 82
 LVM3x3U 82
 LVS1U 54, 57
 LVS1UP 54, 57
 LVSXU 54
 LVSXUP 54
 LWM3x1U 49
 LWM5x1U 49

M

MAC722 97
 MCB1U 67
 MCB1x2U 69
 MCM1U 66
 MCM1x2U 68
 MFIU 95
 MFAU 90
 MFAUB 57
 MFCU 94
 MFD1U 91
 MPAU 90
 MPAUB 57
 MPD1U 91
 MSA1U 35
 MSD1U 36
 MSM1U 35, 57
 MSTU 38
 MTA1U 42
 MTM1U 42, 43
 MTMPIU 42
 MTMS1U 57
 MTTU 46
 MWCU 47

O

ODMLA25 63
 ODMLT 47

P

PAC101 39
 PAC103 39
 PAC400 63, 97
 PAC527 62

PAC710 97
PAC715 63, 97, 80, 97
PAC715/716 97, 80
PAC716 63, 97, 80, 97
PAC722 97
PAC730A 96, 97
PAC900 96
PAC910 96
PACTP1 97
PDRUB 63
PF1U 94
PFCU 94
PG1A 25, 26
PG2A 25, 26
PG3A
PNRUB 63
Portable 96
Portable Flat Panel stand 96
PRSU 96
PSMH 39
PSMH2079 39
PSMH2860 39
PTSU 98

R

RPEU 22
RPMEU 21
RSEU 22
RSMEU 21

S

SEC2 25, 26
SL15li 29
SL220 29
SL236i 29
STLU 98
STMS1U 43, 57
STS1 98
SYSAU 23

T

TA100 61
TA200 61
TA250 61
TA300 61
TA350 61
TA410 61
TPMU 79

TPSU 79
TS110SU 60
TS118SU 60
TS218SU 60
TS318SU 59
TS318TU 59
TS325TU 59
TS525TU 59

V

VCMEU 24

W

WM110AUS 31
WM120AUS 31
WM130AUS 31
WM210AUS 31
WM220AUS 31
WM230AUS 31
WP21US 32
WP22US 32
WP23US 32

X

XBM1U 85
XBM1UP 86
XCB1U 66
XCB7000 67
XCM1U 65
XCM7000 65
XPAU 89
XSM1U 34
XTM1U 41
XVAU 89
XVM1U 94



INSTALLER INSPIRED | milestone.com

USA P 866.977.3901 E chief@milestone.com

CANADA P 877.345.4329 E canadainfo@milestone.com

EMEA P +31 495 580 840 E emea.sales@milestone.com

APAC P +852 2145 4099 E asia.sales@milestone.com

©2018 Milestone AV Technologies. 160292 1/18 Chief is a registered trademark of Milestone AV Technologies. All other brand names or marks are used for identification purposes and are trademarks of their respective owners. All patents are protected under existing designations. Other patents pending.

A brand of  **legrand**

MILESTONE IS NOW LEGRAND

AV Brands Chief | Da-Lite | Projecta | Sanus | Vaddio